



ITU Competition Rules

Approved by the ITU Executive Board, in **November 2015**

Green highlight – added as of November 2015

Red highlight – deleted as of November 2015

The ITU Competition Rules is the master source document, found on ITU's website at www.triathlon.org. The web based document acts as the official (authorised) reference document and is maintained based on authorised amendments in accordance with recommendations by the ITU Technical Committee and accepted by the ITU Executive Board.

Contact

International Triathlon Union (ITU)
Maison du Sport International
Av. de Rhodanie 54
Lausanne CH -1007, Switzerland
Tel +41 21 614 60 30
Fax +41 21 614 60 39
Email: ituhdq@triathlon.org
For general information about ITU visit www.triathlon.org

TABLE OF CONTENTS

1. INTRODUCTION:	4
2. CONDUCT OF ATHLETES:	6
3. PENALTIES:	16
4. SWIMMING CONDUCT:	20
5. CYCLING CONDUCT:	25
6. RUNNING CONDUCT:	33
7. TRANSITION AREA CONDUCT:	34
8. COMPETITION CATEGORIES:	35
9. PRIZES AND AWARDS:	36
10. EVENTS:	38
11. TECHNICAL OFFICIALS:	42
12. PROTESTS:	45
13. APPEALS:	47
14. INDOOR TRIATHLON:	50
15. MIDDLE AND LONG DISTANCE EVENTS:	51
16. TEAM AND RELAY CHAMPIONSHIPS:	52
17. PARATRIATHLON:	54
18. WINTER TRIATHLON:	66
19. CROSS TRIATHLON AND DUATHLON:	69
20. COMPETITION IN QUALIFYING ROUND FORMAT:	70
21. APPENDIX A: RACE DISTANCES AND AGE REQUIREMENTS:	74
22. APPENDIX B: RACE PROTEST FORM:	76
23. APPENDIX C: RACE APPEAL FORM:	78
24. APPENDIX D: DEFINITIONS:	80
25. APPENDICES E: QUALIFICATION AND RANKING CRITERIA	86
26. APPENDICES F: UNIFORM RULES	130
27. APPENDIX G: LINK TO PARATRIATHLON CLASSIFICATION MANUAL:	152
28. APPENDIX H: PRIZE MONEY BREAKDOWN:	175
29. APPENDIX I: ITU RELATED MULTISPORTS:	176
30. APPENDIX J: ITU EVENTS AND ITU EVENT CATEGORIES:	177
31. APPENDIX K: PENALTIES AND VIOLATIONS:	179
32. APPENDIX L: RESULTS AND START LIST SAMPLES	181
33. APPENDIX M: ATHLETES' AGREEMENT	181

1. INTRODUCTION:

1.1. Purpose:

- a.) The International Triathlon Union (ITU) is the sole governing body, responsible for the Competition Rules for Triathlon, Duathlon and its other related multisports. The complete list of sports under the jurisdiction of ITU is included as Appendix A and Appendix J;
- b.) The International Triathlon Union Technical Committee (ITU TC) will ensure technical aspects of ITU competitions are of the highest quality;
- c.) The ITU Competition Rules specify the conduct and behaviour of athletes during ITU competitions. Where the ITU Competition Rules do not specify, the rules of FINA, UCI, IAAF, FIS, IPC swimming, IPC athletics and IPC nordic skiing will apply in their specific segments, unless ITU TC decides otherwise;
- d.) The ITU Event Organisers' Manual and its related documents set safety and logistical standards for host National Federations (NFs) and for the Local Organising Committees (LOCs);
- e.) The ITU Technical Officials' (ITO) Certification Programme sets the standards for certifying ITU Technical Officials;
- f.) It will be clearly indicated when a rule applies to a specific competition.

1.2. Intention:

- a.) The ITU Competition Rules are intended to:
 - (i) Create an atmosphere of sportsmanship, equality, and fair play;
 - (ii) Provide safety and protection;
 - (iii) Emphasise ingenuity and skill without unduly limiting the athlete's freedom of action;
 - (iv) Penalise athletes who gain an unfair advantage.
- b.) Definitions of all terms used in the ITU Competition Rules are provided in Appendix D. Any difficulty in the interpretation or application of the ITU Competition Rules should be referred to the ITU Technical Committee.

1.3. Language and Communication:

- a.) The official language of ITU Events is English:
 - (i) NFs are responsible for providing translation services from/to English for their own athletes;
 - (ii) LOCs will communicate at least in English, even if another language is used in parallel.

1.4. Modifications:

- a.) The ITU Competition Rules will be adapted for other modern multisport competitions, which fall within ITU's jurisdiction;
- b.) An athlete must not be permitted an advantage not intended by a rule, or to conduct him/herself in a dangerous way. To implement this, every infringement related in the ITU Competition Rules has a sanction attached. Officials base their judgments on whether an advantage, not intended by the Rules, has been gained;
- c.) ITU Competition Rules will be applicable to international competitions hosted by National Federations (NFs) affiliated with ITU.

1.5. Exceptions:

- a.) The ITU Competition Rules will be applicable to all events sanctioned by ITU and are to be implemented by the appointed Technical Delegate as appropriate. Where the ITU Competition Rules conflict with the laws of the jurisdiction in which the event is to be held, the ITU Competition Rules will override the laws of the jurisdiction to the extent of the inconsistency. Athletes must be notified of the implications of these laws as early as possible and not later than prior to the start of the event. Exceptions for special circumstances in a particular event may only be gained from ITU with prior approval. A request for an exception to the ITU Competition Rules must be made in writing to the ITU Technical Committee (ITU TC) through the NF to whom the application has been submitted or is being submitted.

1.6. Specific Regulations:

- a.) A Technical Delegate may approve the addition of specific regulations for a particular race, provided that:
 - (i) Each additional specific regulation does not conflict with another ITU Competition Rule;
 - (ii) Each additional specific regulation is made available in written form and is announced at the athletes' briefing; and
 - (iii) Each additional specific regulation and the reasons for its inclusion are advised to the ITU TC one week before the day on which the event is to be conducted. The ITU TC may invalidate the incorporation of an additional specific regulation only on the authority of the ITU Executive Board.

1.7. Intellectual Property

- a.) ITU Events are the exclusive property of ITU which owns all rights associated including, without limitation, the rights to organise, exploit, broadcast and reproduce ITU Events. These rights include any type of digital media, whether that be photographic or video in nature, captured from within the boundaries of the field of play, regardless of ownership of the capturing device. All the personal data from the athlete entered into any ITU event and the data produced from the event, including the results are exclusive property of ITU.

1.8. Unauthorised Exceptions or Additions:

- a.) The unauthorised exception to, or addition of, a Competition Rule will prevent an event from being sanctioned and will invalidate a sanction, which has already been granted to an event. This could result in legal complications, particularly in the case of accidents during the event and in subsequent requests for approval from NFs and/or municipal authorities to use roads and waterways. Insurance authorities have also warned that claims made under such circumstances may be considered invalid.

1.9. Rule Updates:

- a.) The ITU Competition Rules may be changed from time to time by the ITU TC at its discretion, with the approval of the ITU Executive Board. Any rule change(s) shall be advised in writing to affiliated NFs at least 30 days before it/they is/are to take effect. Updated ITU Competition Rules will be posted on the ITU website (www.triathlon.org).

2. CONDUCT OF ATHLETES:

2.1. General Conduct:

- a.) Triathlon and ITU's other related multisports involve many athletes. Race tactics are part of the interaction between athletes. Athletes will:
 - (i) Practice good sportsmanship at all times;
 - (ii) Be responsible for their own safety and the safety of others;
 - (iii) Know, understand and follow the ITU Competition Rules, available from their NFs and on www.triathlon.org;
 - (iv) Obey traffic regulations and instructions from race officials;
 - (v) Treat other athletes, officials, volunteers, and spectators with respect and courtesy;
 - (vi) Avoid the use of abusive language;
 - (vii) Inform a Technical Official after withdrawing from the race. In case the athletes fail to do this, it may result in a suspension;
 - (viii) Compete without receiving assistance other than from event personnel and officials;
 - (ix) Avoid using ambush marketing;
 - (x) Not dispose of rubbish or equipment around the course except at clearly identified places, such as aid stations or rubbish disposal points. All items must be kept with the athlete and returned to their transition spot;
 - (xi) Not attempt to gain an unfair advantage from any external vehicle or object;
 - (xii) Follow the prescribed course.

2.2. Outside assistance:

- a.) The assistance provided by event personnel or Technical Officials is allowed but is limited to providing drinks, nutrition, mechanical and medical assistance, upon the approval of the Technical Delegate or Race Referee. Athletes competing in the same race may assist each other with incidental items such as, but not restricted to, nutrition and drinks after an aid station and pumps, tubular tires, inner tubes and puncture repair kits;
- b.) Athletes may not provide any item of equipment to an athlete competing in the same race which results in the donor athlete being unable to continue with their own race. This includes but is not restricted to shoes, complete bicycle, frame, wheels and helmet. The penalty for this will be disqualification of both athletes.

2.3. Drug Abuse:

- a.) Athletes and guides will follow the ITU Anti-Doping Rules;
- b.) All athletes and guides are responsible for familiarising themselves with the ITU Anti-Doping Rules including medical and doping control tests, testing obligations, rights, responsibilities and procedures, penalties and appeal processes, and prohibited substances and methods;
- c.) ITU has implemented the ITU Anti-Doping Rules and abides by rules set by the World Anti-Doping Agency (WADA) Code.

2.4. Health:

- a.) Triathlons and ITU's other related multisports are strenuous. To be able to compete, athletes should be in excellent physical condition. Their health and welfare is of paramount importance. By starting in a race, the athletes declare they are in good health and are in appropriate physical condition to complete the race;
- b.) Time limits for the swim leg, bike leg and overall finish time may be established for each competition by the Technical Delegate. These limits must be published in the pre-event registration material;
- c.) ITU encourages athletes to undergo a periodic health evaluation (PHE) including a 12 lead electrocardiogram (ECG) and to undergo a pre-participation evaluation (PPE) prior to engaging in competitive sport. PPE will be mandatory for all Junior athletes from January 1st 2017.

2.5. Eligibility:

- a.) All athletes must be in good standing with their National Federations. To ensure this, all the entries must be done by the NFs, not by the athletes themselves;
- b.) Athletes under suspension are not allowed to compete in any ITU event, in any competition sanctioned by ITU members, or in any competition held under the ITU Rules;
- c.) An athlete's age is determined by their age on December 31st in the year of competition;
- d.) Athletes aged 15 to 17 years old are eligible to compete in the Youth category;
- e.) Athletes aged 16 to 19 years old are eligible to compete in the Junior category;
- f.) Athletes aged 18 to 23 years old are eligible to compete in the U23 category;
- g.) The different qualification criteria are published in Appendix E, Continental Championships Qualification Criteria are established by the ITU Continental Confederations and published in www.triathlon.org;
- h.) Specific qualification criteria affecting Major Games and Recognised Games are published in www.triathlon.org;
- i.) Athletes may not compete within 36 hours (as determined by the start times of the first wave) in more than one triathlon or multisport event (see Appendix I) when one event is of standard distance or longer. Exceptions will be for the PT5 guides and team relay events at the defined super-sprint distances (see 16.1.a.);
- j.) Age limits: athletes must be a minimum age to compete in any ITU Event, as outlined in Appendix A. Continental Confederations may add other age limits for Continental Championships, for youth categories with super-sprint events. The age limits as outlined in Appendix A cannot be modified;
- k.) An athlete who competes in a category different from his/her age, in a distance in which it is not allowed, or before the 36 hour period, will be disqualified from the events he/she took part in. Any awards, prizes and points will be removed;
- l.) An athlete who undergoes sexual reassignment and wishes to participate in ITU events must meet all the current conditions and criteria established by the IOC prior to doing so. The request to participate in ITU events further to said sexual reassignment must be made expressly by the athlete to the ITU Medical and Anti-doping Committee at least 30 days prior to event in which he or she wishes to compete. The ITU Medical and Anti-doping Committee shall determine whether or not the current IOC criteria have been met and provide the athlete a written and reasoned decision to that effect. Any such decision on eligibility may be appealed as a Level 3 appeal (see 13.1 and 13.2.c.);
- m.) Where the eligibility of a female athlete is questioned due to possible hyperandrogenism and a formal written request has been made to do so, the ITU Medical and Anti-doping Committee and other experts shall evaluate the suspected case of female hyperandrogenism. In so doing, the ITU Medical and Anti-doping Committee shall respect and apply the current IOC Regulations on Female Hyperandrogenism which are

in effect at the time of the request. The ITU Medical and Anti-doping Committee will then notify the athlete in question of its determination by way of a written and reasoned decision. Any such decision on eligibility may be appealed as a Level 3 appeal (see 13.1 and 13.2.c.);

n.) Athletes who are competing under ITU flag will be entered in the races by the NF the athlete is moving to. They will compete with the same rights than any other athlete in terms of awards, prizes and points.

2.6. Insurance:

- a.) All athletes competing in an ITU event must have personal insurance coverage guaranteed by their NF. This insurance will cover:
 - (i) Any accident occurring before, during and after any competition;
 - (ii) Any sickness that an athlete could suffer during a trip to a competition or event;
 - (iii) Liability caused by an athlete during the competition.
- b.) The athlete's NF guarantees the existence of this insurance by entering an athlete in an event. LOCs or NFs organising an event cannot force the athletes to pay for a race day fee for insurance purposes.

2.7. Registration:

- a.) Entry:
 - (i) NFs will register their athletes for ITU events following their NF qualification system or other ITU approved qualification system;
 - (ii) Elite, U23 Junior, Youth and Paratriathletes qualify by the eligibility rules outlined in 2.5 and Appendix E of the ITU Competition Rules;
 - (iii) Prior to competing in ITU Triathlon World Cups or ITU World Triathlon Series events, World Paratriathlon Events and Multisport World Championships, Elite, U23, Junior athletes and Paratriathletes must sign the ITU Athletes' Agreement, which states that any dispute arising from the ITU Rules that cannot be settled by its existing appeal procedure, shall be settled finally by the Court of Arbitration for Sport (CAS) to the exclusion of recourse to ordinary courts. Once signed, the ITU Athletes' Agreement is valid until the end of the competition year it has been signed in. The Athletes' agreement is included in Appendix M;
 - (iv) NFs are responsible for entering their athletes and coaches for all ITU Events using the ITU online system on www.triathlon.org;
 - (v) All Age Group, Youth, Junior and U23 athletes must provide picture ID at race registration/packet pick-up prior to competition.
- b.) Pre-Race Briefings:
 - (i) Coaches' Meeting: If a coaches' meeting is scheduled, it will take place one hour before the Athletes' Briefing. The TD will conduct the Coaches' Meeting. The agenda will include the announcement of the Competition Jury and all the technical details of the event as well as specific information for coaches. Coaches' accreditations will be distributed at this meeting, or if the Coaches' Meeting is not scheduled, accreditations will be distributed at the end of the Elite/U23/Junior/Youth Athletes' Briefing;
 - (ii) Age Group Team Managers' and Coaches' Briefing: At World Championships, the TD will conduct the Age Group Team Managers' and Coaches' briefing. Only Age Group Team Managers and Coaches [registered on www.triathlon.org](http://www.triathlon.org) are allowed to attend. The agenda of this briefing will include the announcement of the

Competition Jury and all the necessary information for the event. A separate briefing will be conducted for Paratriathlon;

- (iii) Paratriathlon Team Managers' Meeting. If a Paratriathlon Team Managers' Meeting is scheduled, it will take place before the Paratriathlon Briefing. The TD will conduct it and the agenda will include the announcement of the Competition Jury and all technical details of the event as well as the specific information on paratriathlon procedures;
- (iv) Elite/U23/Junior/Youth Briefings: At all ITU Events, the TD will conduct the Athletes' Briefing. Elite/U23/Junior/Youth athletes must be in attendance. Coaches may also attend the briefing. The following penalties apply to athletes who miss the briefing:
 - Athletes not attending the briefing, without informing the TD about their absence, will be removed from the start list;
 - Athletes entering the briefing hall after the briefing has started and athletes not attending the briefing, but who have informed the TD about their absence, will be reallocated to the last position on the pre-start line up, if the event starts with a swim segment. Athletes will be penalised with a time penalty to be served in the first run, if the event starts with a run segment;
 - For the World Triathlon Series or ITU Triathlon World Cup events, if an athlete misses more than two briefings in a calendar year, they will be removed from the start list for the third missed briefing and each missed briefing thereafter.
- (v) Athletes must register prior to entering the briefing venue;
- (vi) For Triathlon World Series and ITU Triathlon World Cup events, there is one single Athletes' Briefing for female and male elite athletes. This briefing will be held at 18:00 local time two (2) days prior to the first elite competition day. For all other ITU events or for other athlete categories (U23, Junior, Youth), the briefing will take place at 18:00 either one (1) or two (2) days before the first competition day of the related event and category. Alteration to this time should be announced on the ITU website 45 days in advance.

c.) Packet Pick-Up:

- (i) All ITU events - Age Group:
 - All athletes must pick up their own race packet at the official race registration area during a designated time. Packet pick-up will be opened on two (2) separate days, starting from 3 days prior to their competition. The hours shall be from 09:00 to 19:00. If an NF is unable to make the designated registration time, they must request a different time at least 14 days in advance, in writing to ITU;
 - The race packets will contain a minimum of: five (5) official race numbers (one (1) for body, one (1) for bicycle and three (3) for helmet) and four (4) safety pins, numbered swim cap, timing chip, accreditation pass, athletes' guide, tickets for all of the social functions. LOC gifts may be distributed at the same time.
- (ii) All ITU Events - Elite, U23, Junior and Youth Competitions:
 - All athletes will pick up their own race packet at Registration following the Athletes' Briefing;

- The race packet will include: three (3) helmet numbers, one (1) bike number, body decals for both arms and both legs, accreditation pass, athletes' guide, tickets for all of the social functions. LOC gifts may be distributed at the same time.
- d.) Check-in:
- (i) AG races with more than 700 athletes entered will schedule the Check-in the day before the race. AG events with fewer athletes, and Elite, U23, Junior, Youth and Paratriathlon will have the bike check on same day;
 - (ii) Technical Officials will conduct the check-in at the athletes' lounge or at the transition area and will include the following:
 - Distribution of the swim caps and timing chips (except for the AG events);
 - Control of the athletes' uniform, which must comply with the ITU Uniform Rules. (Appendix F). Each uniform should be photographed. If an athlete needs to replace the uniform, this process has to be done again;
 - The bike check is regulated under section 5.3;
 - Distribution of the race packets to the athletes who missed the briefing.

2.8. Uniform:

- a.) All athletes competing in ITU events are required to wear their uniform conforming to the ITU Uniform Rules (see Appendix F);
- b.) The ITU Uniform Rules set the space limitation on the athletes uniforms to include commercial logos. It is not permitted to display any kind of demonstration of political, religious or racial propaganda;
- c.) Athletes must follow the following rules with respect to wearing uniforms:
 - (i) Athletes must wear the uniform during the entire competition and award ceremony;
 - (ii) The uniform must cover the whole torso in the front. The back may be uncovered from the waist up;
 - (iii) Arms below the shoulders must be uncovered. Long sleeves and long pants are allowed for the award ceremony. The TD may authorise this area to be covered based on the weather conditions. Wetsuits, when authorised, may cover the arms but not the hands. Athletes competing in middle and long distance events and Paratriathletes competing in PT1 class are allowed to wear uniforms with sleeves extending from the shoulder to the elbow. This paragraph does not apply to Winter Triathlon events;
 - (iv) Covering the legs below the knees is not allowed in the swim segment when the use of wetsuits is forbidden, but is allowed in the swim segment when the use of wetsuits is allowed. It is also allowed in all of the other segments;
 - (v) A one-piece uniform is preferred. If a two-piece uniform is used, the space between the top and the bottom may not be visible, so the two pieces overlap. The athlete must cover the torso during the entire race;
 - (vi) If the suit has a zipper it will be located at the back (except for middle and long distance events) and will not be longer than 40 cm;
 - (vii) The uniform must be worn over both shoulders for the duration of the competition;
 - (viii) Elite, U23, Junior and Youth athletes must wear the same uniform from the start to the finish, in events of standard distance or shorter;

- (ix) Rain jackets are allowed when the TD authorises it. Rain jackets must be the same design and colour as the uniform or transparent;
 - (x) Failure to comply with the ITU Competition Rules (including the Uniform Rules) related to the uniform may result in an athlete having to wear a triathlon suit supplied by ITU. Alternatively, Technical Officials may request the athlete use a permanent marker or other means to eradicate logos on the uniform that do not comply with the Competition Rules. If during the race or the award ceremony, athletes wear a uniform with logos that do not comply with the Competition Rules (including the Uniform Rules), he/she will be disqualified.
- d.) For reasons of religion, athletes are allowed to have the body totally covered (except the face) provided that:
- (i) The uniform material is approved by FINA (applicable only for the non-wetsuit swim);
 - (ii) The uniform will not interfere with the bicycle mechanisms;
 - (iii) Extra identification elements are to be worn over the uniform, following the TD's instructions.

2.9. Race numbers:

- a.) Official race numbers must be worn by athletes during the run segment when it is provided. The official race number must be visible on the front. Elite, U23, Junior and Youth athletes will not wear official race numbers. When, due to the race schedule AGs are mixed with other athletes the TD can decide on making the use of the official race numbers mandatory for all the athletes;
- b.) Official race numbers are mandatory for all in the Winter Triathlon events;
- c.) Official race numbers may be worn in the bike and wetsuit swim segments;
- d.) Official race numbers are forbidden in a non wetsuit swim segment;
- e.) The use of the official race number in Paratriathlon is regulated in Chapter 17;
- f.) Body marking:
 - (i) The LOC will provide body marking decals for the Elite athletes, who will apply them prior to the event;
 - (ii) Body markings are to be applied to each arm and leg, unless instructed otherwise by the ITU TD at the briefing;
 - (iii) Body markings and/or decals using multiple digits will have numbers appearing one above the other, not side by side;
 - (iv) For Age Group events, one calf of each athlete must be marked with the category and gender of the athletes (For example, the number M25 would appear on a male athlete in the 25 – 29 age category or F25 should appear on a female athlete in the same category).

2.10. Assignment of race numbers:

- a.) General:
 - (i) Athletes' race numbers are assigned based on previous race results in similar events, by using the most related rankings or points list;
 - (ii) The Elite men's and women's events will be numbered starting with number 1, except in Long Distance events;

- (iii) Number 13 will be not used.
- b.) Specific events numbering criteria:
- (i) World Triathlon Series (WTS) and Grand Final:
 - First criteria: Current WTS rankings;
 - Second criteria: ITU Points List;
 - Third criteria: random.
 - (ii) Triathlon U23 World Championships:
 - First criteria: Current WTS rankings;
 - Second criteria: ITU Points List;
 - Third criteria: random.
 - (iii) Junior - Any event:
 - First criteria: ITU Points List;
 - Second criteria: Applicable Continental Junior Rankings (For example ETU, CAMTRI);
 - Third criteria: random.
 - (iv) Triathlon World Cup events:
 - First criteria: ITU Points List;
 - Second criteria: random.
 - (v) Triathlon Continental Cup events:
 - First criteria: ITU Points List;
 - Second criteria: Continental Points List from the same continent as the event;
 - Third criteria: random.
 - (vi) Triathlon Elite Continental Championships:
 - First criteria: Top 10 classification of the related Continental Championships in the previous year;
 - Second criteria: ITU Points List;
 - Third criteria: Continental Points List from the same continent of the event;
 - Fourth criteria: random.
 - (vii) Triathlon U23 Continental Championships:
 - First criteria: ITU Points List;
 - Second criteria: random.
 - (viii) Multisport – Any Elite event:
 - First criteria: ITU Related Rankings;
 - Second criteria: random.
 - (ix) Age Group - Any event:
 - First criteria: Age Group by Age Group;
 - Second criteria: Grouped by nations in alphabetical order starting by the host nation.
 - (x) Paratriathlon; any event:
 - First criteria: Athlete sport class in this order PT5F, PT5M, PT4F, PT4M, PT3F, PT3M, PT2F, PT2M, PT1F and PT1M;

- Second criteria: Paratriathlon Points List;
 - Third criteria: random.
- (xi) Team Relay- Any event:
- First criteria: One team per nation;
 - Second criteria: Same team event the preceding year;
 - Third criteria: random.
- c.) Numbering of the final of events with a qualifying round format is regulated in 20.5.

2.11. Timing and Results:

- a.) A race will be won by the athlete who has the shortest time from the start signal to the moment when the athlete finishes the race as defined in 6.2 a), 17.14 d) and 18.10, **except if the event is conducted under the "rolling start system" as defined in 4.8.**
- b.) The official results will list the athletes according to their finish time and in accordance with the ORIS standards, a sample of the results format is included in Appendix L. In the event that two athletes tie for a place, and their performances cannot be separated, they will be awarded the same rank, and the next athlete to finish behind them will occupy the same rank plus two places, with the subsequent athletes ranked in order of finishing. Time splits to be included are:
- (i) Swim or first segment;
 - (ii) Transition 1;
 - (iii) Bike or second segment;
 - (iv) Transition 2;
 - (v) Run or third segment;
 - (vi) Overall finish time.
- c.) Results will include athletes who do not finish the race (DNF), any lapped athletes (LAP), ineligible Paratriathletes (NE), not classified teams (NC), those who are disqualified (DSQ) and athletes or teams which did not start (DNS) and listed in this order:
- (i) Athlete's marked DNF or LAP (together in one group) are listed first, followed by NC, NE, DSQ and finally DNS;
 - (ii) If more than one athlete is marked DNF or LAP, those who completed the most laps should be listed first; if several athletes are marked DNF or LAP on the same lap, athletes should be listed according to their times at the previous timing point with the fastest first, or by ascending start number if no times were recorded up to the point at which they retired;
 - (iii) If more than one team is marked NC, they should be listed within the same group according to ascending start number;
 - (iv) If more than one Paratriathlete is marked NE, they should be listed within the same group according to ascending start number;
 - (v) If more than one athlete is marked DSQ, they should be listed within the same group according to ascending start number;
 - (vi) If more than one athlete is marked DNS, they should be listed within the same group according to ascending start number;

- (vii) For DSQ athletes, achieved results and ranking (from previous race stages) should not be displayed.
- d.) Additional information will be displayed either at the header or the footer of the results:
 - (i) Swim distance and number of laps;
 - (ii) Bike distance and number of laps;
 - (iii) Run distance and number of laps;
 - (iv) Air temperature;
 - (v) Water temperature;
 - (vi) Wetsuit swim/No wetsuit swim;
 - (vii) Name and country of the Technical Delegate;
 - (viii) Name and country of the Race Referee;
 - (ix) Name and country of the Competition Jury Members.
- e.) For relay events, the rules above are applicable and the total time per athlete will be shown;
- f.) Results will be official once the Race Referee signs them. Incomplete results can be declared official at any time. The Race Referee will use all the resources available to decide the final position of every athlete. The information from technology will be used to assist in the decision making process. The Race Referee may decide, based on the available evidence, that a race is tied if there is no way of defining which athlete crossed the line first. Results of tied athletes will be sorted according to race numbers. However, athletes who finish in a contrived tie situation, where no effort to separate their finish times has been made will be DSQ;
- g.) Paratriathletes changing sport class after classification assessment before the event will be moved to the new sport class. Ineligible Paratriathletes will be removed from the start list;
- h.) Paratriathletes changing sport class after observation during competition will be moved to a new sport class. Ineligible Paratriathletes will be displayed as NE.

2.12. Exceptional conditions:

- a.) The following list highlights some of the exceptional situations that may happen. Different scenarios from those indicated may arise, which need to be solved by the TD following the same principles.
 - (i) Before the race:
 - A triathlon may be modified to a duathlon, aquathlon, or even in a 2 segments race: swim-run, bike-run or run-bike, in the equivalent distance. Time trial starts are allowed;
 - A duathlon may be modified to two segments: bike-run or run-bike. Time trial starts are allowed;
 - The TD may take other decisions if the above options are not possible to set up.
 - (i) Modification of the race once started:
 - Any segment, but only one, may be shortened during the race. The TD and TOs will take all reasonable actions to ensure the fairness of the event and the safety of the athletes. Otherwise, the race will be stopped.
 - (ii) Modification of the third segment by shortening it:
 - The athletes will stop the race no later than the completion of the lap. Those who completed more than the 50% of the last segment will be considered as finishers and will be ranked according to the position in the preceding lap. All of the others, or if the race is stopped before that moment, will not be considered in the results;

- In the case that all the athletes are stopped before the 50% of the third segment the race will be restarted, if possible.

3. PENALTIES:

3.1. General Rules:

- a.) Failure to comply with the ITU Competition Rules may result in an athlete being verbally warned, punished with a time penalty, disqualified, suspended, or expelled;
- b.) The nature of the rule violation will determine the subsequent penalty;
- c.) A suspension or an expulsion will occur for very serious violations of either the ITU Competition Rules or the ITU Anti-Doping Rules;
- d.) Reasons for penalty: An athlete may be issued a verbal warning, punished with a time penalty, or disqualified for failing to abide by the ITU Competition Rules. Infringements and penalties are listed in Appendix K;
- e.) The Technical Officials are allowed to assess penalties, even if the infringement is not listed, if the Technical Official deems an unfair advantage has been gained, or if a dangerous situation has been created intentionally.

3.2. Warning:

- a.) The purpose of a warning is to alert an athlete about a possible rule violation and to promote a "proactive" attitude on the part of officials;
- b.) A warning may be given when:
 - (i) An athlete violates a rule unintentionally;
 - (ii) A Technical Official believes a violation is about to occur;
 - (iii) No advantage has been gained.
- c.) Giving a warning: The Official will blow their whistle, the athlete will be stopped if necessary, asked to modify their behavior, and allowed to continue the race immediately afterwards.

3.3. Stop and Go:

- a.) A stop and go can be used by a Technical Official to get an athlete to correct a minor infringement.
- b.) The Technical Official will hold up a yellow card and call the athlete's number (if known) to impose a stop and go.
- c.) A stop and go is not considered a time penalty and is therefore not included in any accumulated time penalties.

3.4. Time Penalty:

- a.) It is not necessary for a Technical Official to give a warning prior to issuing a more serious penalty;
- b.) A time penalty is appropriate for minor infringements;
- c.) Time penalties will be served in a designated penalty box or in the transition area.
- d.) Giving a time penalty: A warning will be given at the discretion of the Technical Official. A blue card will be used for drafting infringements during the bike segment, and a yellow card will be used for the rest of the infringements. If time and conditions permit, a Technical Official will assess a time penalty by:
 - (i) Sounding a whistle or horn; showing a blue or yellow card; calling in English the athlete's number and saying "Time penalty". For safety reasons, a Technical Official may have to delay issuing a warning;
 - (ii) Alternatively, athletes may be informed about penalties by displaying the athlete's number on a panel posted at the entrance of the penalty box. It is the athlete's responsibility to check this board;

- e.) Procedure while serving a time penalty:
- (i) When given a blue or yellow card, the athlete will follow the instructions of the Technical Official;
 - (ii) Time penalty in transition 1 (for any infringements up to this point):
 - The Technical Official will hold a yellow card as the penalised athlete arrives at his/her position. The athlete will be ordered to stop in his/her transition space without touching any of their equipment. If the athlete touches or removes any of their equipment the counts will stop;
 - Once the athlete stops, the Technical Official starts to time the penalty;
 - When the penalty time has been completed, the Technical Official will say "Go" and the athlete can continue with the race.
 - (iii) Time penalty at the bike penalty box:
 - The Technical Official will hold a blue card and, if conditions permits, tell the athlete to report to the next penalty box and follow the instructions of the Technical Official there.. It is the athlete's responsibility to report to the next penalty box on the course after receiving notification. Athlete race numbers are not posted for a bike penalty box;
 - The penalised athlete will enter the penalty box and inform the Technical Official of their identity and number of penalties to serve. The time penalty starts when the athlete enters the penalty box and ends when the Technical Official says "Go", at which time the athlete may continue with the race.
 - (iv) Time penalty at the run penalty box:
 - The penalised athletes' numbers will be clearly displayed on a board before the penalty box;
 - The penalised athlete will proceed into the penalty box and inform the Technical Official of their identity and number of penalties to serve. The time penalty starts when the athlete enters the penalty box and ends when the Technical Official says "go", at which time the athlete may continue with the race;
 - The penalised athlete's number will be removed from the board once the penalty is served;
 - A penalised athlete may serve their penalty on any lap of the run;
 - For relay events, the penalty may be served by any member of the team, who has not yet completed their portion of the event;
 - Penalties must be posted on the board before the athlete completes the first half of the run. Postings after this time are invalid.

3.5. Disqualification:

- a.) General:
- (i) A disqualification is a penalty appropriate for severe rule violations, such as but not limited to, repeated bike draft infringements, and/or dangerous or unsportsmanlike conduct;
 - (ii) For the Age Group and Paratriathletes, the accumulation of time penalties will result in disqualification as follows:
 - Two time penalties in the standard distance or shorter events;
 - Three time penalties in the middle and long distance events.
- b.) Assessment:
- (i) If time and conditions permit, a Technical Official will assess a disqualification by:
 - Sounding a whistle or horn;
 - Showing a red card;

- Calling (in English) the athlete's number and saying "Disqualified";
 - For safety reasons, a Technical Official may have to delay issuing a disqualification.
- (ii) Alternatively, the athletes may be informed about the penalties by displaying the athlete's number on the white board posted at the post finish area.
- c.) Procedure after Disqualification:
- (i) An athlete may finish the race if a Technical Official issues a disqualification.

3.6. Suspension:

- a.) General:
- (i) A suspension is a penalty appropriate for a fraudulent or a very severe rule violation, such as but not limited to repeated dangerous or unsportsmanlike conduct;
- (ii) A suspended athlete will not take part in ITU competitions or competitions sanctioned by NFs affiliated with ITU during a suspension period.
- b.) Assessment:
- (i) The Race Referee will submit a report to the **ITU Arbitration Tribunal** including all the details of the action, and the reasons to recommend the athlete for suspension. This report will be submitted to the ITU Secretary General within one week of the competition. The ITU Secretary General will inform the affected NFs.
- c.) Suspensions will be assessed by the **ITU Arbitration Tribunal** for periods of three (3) months to four (4) years, depending on the violation;
- d.) Suspensions based on contriving the ITU Anti-doping Rules: If the suspension is an Anti-doping Rule Violation, the athlete will not be able to compete in any other sport whose federation is recognised by ITU, IOC or SportAccord and vice versa.
- e.) Reasons for Suspension:
- (i) A list of infringements, which may result in a suspension, is described in Appendix K.
- f.) Disciplinary Notice:
- (i) When an athlete is suspended, the ITU will notify the concerned NF, in writing, within 30 days;
- (ii) All suspensions will be announced in the ITU newsletter and communicated to the IOC and respective parties.

3.7. Expulsion:

- a.) General:
- (i) Athletes who have been expelled will not participate in ITU competitions or competitions sanctioned by NFs affiliated with ITU for life.
- b.) Reasons for Expulsion:
- (i) An athlete will be expelled for life for repeated rule violations that incur suspension as the penalty;
- (ii) Expulsion due to an Anti-doping Rule Violation: If the expulsion is for an Anti-doping Rule Violation, the athlete will not be able to compete in any other sport whose federation is recognised by ITU, IOC or SportAccord and vice versa.

c.) Disciplinary Notice:

- (i) When an athlete is expelled, the ITU will notify the concerned NF, in writing, within 30 days;
- (ii) Expulsions will be announced in the ITU newsletter and communicated to the IOC and the respective parties.

3.8. Right of Appeal:

- a.) Athletes punished with a penalty have the right to appeal.

3.9. Reinstatement:

- a.) After suspension, an athlete must apply to the **ITU Arbitration Tribunal** for reinstatement.

4. SWIMMING CONDUCT:

4.1. General Rules:

- a.) Athletes may use any stroke to propel themselves through the water. They may also tread water or float. Athletes are allowed to push off the ground at the beginning and the end of every swim lap;
- b.) Athletes must follow the prescribed swim course;
- c.) Athletes may stand on the bottom or rest by holding an inanimate object, such as a buoy or stationary boat;
- d.) In an emergency, an athlete should raise an arm overhead and call for assistance. Once official assistance is rendered, the athlete must retire from the competition.

4.2. Wetsuit Use:

- a.) Wetsuit use is governed by the following tables:

Elite, U23, Junior and Youth athletes:

Swim Length	Forbidden	Mandatory
Up to 1500 m	20 °C and above	15.9 °C and below
1501 m and longer	22 °C and above	15.9 °C and below

Age Group athletes:

Swim Length	Forbidden	Mandatory
Up to 1500 m	22 °C and above	15.9 °C and below
1501 m and longer	24.6 °C and above	15.9 °C and below

- b.) Maximum stay in water:

Swim Length	Elite, U23, Junior and Youth	Age Groupers
Up to 300 m	10 min.	20 min.
301 m to 750 below 31°C	20 min.	30 min.
301 m to 750 above 31°C	20 min.	20 min.
751 m to 1500m	30 min.	1h 10 min.
1501 m to 3000m	1 h 15 min.	1 h 40 min.
3001 m to 4000m	1 h 45 min.	2 h 15 min.

4.3. Modifications:

- a.) The swim distance can be shortened or even cancelled according to this table:

Original swim distance	Temperature of water						
	Above 32.0 °C	31.9°C-31.0 °C	30.9 °C – 15.0 °C	14.9 °C – 14.0 °C	13.9 °C – 13.0 °C	12.9 °C – 12.0 °C	Below 12.0 °C
750 m	Cancel	750 m	750 m	750 m	750 m	750 m	Cancel
1500 m	Cancel	750 m	1500 m	1500 m	1500 m	750 m	Cancel
3000 m	Cancel	750 m	3000 m	3000 m	1500 m	750 m	Cancel
4000 m	Cancel	750 m	4000 m	3000 m	1500 m	750 m	Cancel

* **Note:** The temperatures above are not always the water temperature used in the final decision. If the water temperature is lower than 22°C and the air temperature is lower than 15°, then the adjusted value is to decrease the measured water temperature according to the next chart.

(*)		Air temperature							
		15 °C	14 °C	13 °C	12 °C	11 °C	10 °C	9 °C	8 °C
Water Temperature	22 °C	21.0 °C	20.5 °C	20.0 °C	19.5 °C	19.0 °C	18.5 °C	18.0 °C	17.5 °C
	21 °C	20.5 °C	20.0 °C	19.5 °C	19.0 °C	18.5 °C	18.0 °C	17.5 °C	17.0 °C
	20 °C	17.5 °C	17.0 °C	16.5 °C	16.0 °C	15.5 °C	15.0 °C	14.5 °C	14.0 °C
	19 °C	17.0 °C	16.5 °C	16.0 °C	15.5 °C	15.0 °C	14.5 °C	14.0 °C	13.5 °C
	18 °C	16.5 °C	16.0 °C	15.5 °C	15.0 °C	14.5 °C	14.0 °C	13.5 °C	13.0 °C
	17 °C	16.0 °C	15.5 °C	15.0 °C	14.5 °C	14.0 °C	13.5 °C	13.0 °C	Cancel
	16 °C	15.5 °C	15.0 °C	14.5 °C	14.0 °C	13.5 °C	13.0 °C	Cancel	Cancel
	15 °C	15.0 °C	14.5 °C	14.0 °C	13.5 °C	13.0 °C	Cancel	Cancel	Cancel
	14 °C	14.0 °C	14.0 °C	13.5 °C	13.0 °C	Cancel	Cancel	Cancel	Cancel

- b.) If other weather conditions dictate, i.e., high winds, heavy rain, changing temperature, current, etc. the Technical and Medical Delegates may adapt limits of the swim length or adopt provisions about the use of wetsuits. The final decision will be made one hour before the start and will be clearly communicated to the athletes by the Technical Delegate;
- c.) For aquathlon events, if the water temperature is below 22 °C the event will be modified to a Swim-Run event;
- d.) Water temperature must be taken one hour prior to the start of the event on race day. It must be taken at the middle of the course and in two other areas on the swim course, at a depth of 60 cm. The lowest measured temperature will be considered as the official water temperature.

4.4. Starting Position Selection: (Elite/U23/Junior/Youth athletes):

- a.) Prior to the start of competition, athletes are lined up in the order of their start numbers, unless their positions have been reallocated after the Athletes' Briefing;
- b.) The athletes go directly to their selected numbered position upon entering the pontoon and stay in that position behind the pre-start line until the start procedure. A selected position cannot be changed by any athlete during the Starting Position Selection process. An athlete cannot occupy more than one start position;
- c.) Start Line Technical Officials note each athlete's race number and the starting position selected;
- d.) Starting Position Selection ends when every athlete is in a starting position.

4.5. Start Procedure: (Elite/U23/Junior/Youth Athletes):

- a.) After all athletes are in position (confirmed and noted by the Start Line Technical Officials) "On your marks!" is announced and the athletes step forward to the start line (without stepping on it);
- b.) Any time after the announcement, the start signal will be given by blasting a horn. Athletes will move straight ahead towards the first buoy until they will reach the water.
- c.) Technical Officials involved in the start procedure are:
 - (i) Two Start Technical Officials are standing next to each other in the middle of the start area behind the athletes:
 - The first Start Technical Official is responsible for announcing "On your marks";
 - The second Start Technical Official is responsible for giving the start signal.

- (ii) Two False Start Technical Officials stand on both sides of the start area to have a clear view of the start:
 - An air horn is used to provide a false start signal (several short horn blasts);
 - A photo/video camera is used to identify early starters.
- d.) False Start: In case of a false start (several athletes move forward before the start horn) the athletes must come back to their previously selected position. This will be controlled by the Start Line Technical Officials and the start procedure will begin again;
- e.) Valid Start with Early Starters: In the case of an early start of a few athletes, the race can continue, the False Start Technical Officials can decide that the start is valid. The early starters will receive a time penalty in Transition 1, according to the distance of the race (10 seconds for sprint, 15 seconds for standard and 30 seconds for middle and long distance). . In case of relay events, the time penalty has to be served by the first athlete of the team;
- f.) The same procedure will apply for the start of any other multisport event starting with running with adaptations from swim start to run start.

4.6. Start procedure (Age Group athletes):

- a.) Athletes are grouped at the pre start areas according to the assigned start wave;
- b.) Athletes will be called to the start area and they will occupy the start positions according to the TOs instructions;
- c.) After all athletes are in position "On your marks!" is announced;
- d.) Any time after the announcement, the start signal will be given by blasting a horn. Athletes will move forward;
- e.) False Start: In case of a false start (several athletes move forward before the start horn) the athletes must come back to their previously selected position. This will be controlled by the Start Line Technical Officials and the start procedure will begin again;
- f.) Valid Start with Early Starters: In the case of an early start of a few athletes, the race can continue, the False Start Technical Officials can decide that the start is valid. The early starters will time penalty in Transition 1, according to the distance of the race (10 seconds for sprint, 15 seconds for standard and 30 seconds for middle and long distance);
- g.) The same procedure will apply for the start of any other multisport event starting with running with adaptations from swim start to run start;
- h.) Athletes starting in a wave before the one that the athlete is assigned to, will be disqualified;
- i.) Athletes who are late to the assigned wave will need the approval of the Start Technical Official. The athlete start time will be the start time of the assigned wave.

4.7. Start procedure (Interval Start System):

- a.) Athletes are responsible for being at the start line on time;
- b.) A video camera shall be used to record the entire start;
- c.) The Start Technical Officials are responsible for synchronizing their own and the Timekeepers' watches;
- d.) Start Officials must provide all athletes with the opportunity to start at their correct times. An assistant responsible for recording the details for any violations at the start must be placed near the starter. The athletes' actual start time must be noted with both

electric and hand timing, in case the Competition Jury decides his/her late start was due to force majeure;

- e.) Athletes will be called to the start area and will occupy the start positions according to the TOs' instructions;
- f.) Ten minutes before their start time, all the athletes should be ready at the start area;
- g.) Five minutes before their start time, athletes will be asked to take their position at the start area;
- h.) One minute before their start time, athletes will be asked to enter the water, or approach the start line;
- i.) When all athletes are in position, the "start procedure" will be initiated. "On your marks!" will be announced;
- j.) The start signal (horn blast) will be sounded at the exact start time of the wave;
- k.) An athlete who is an "early starter" in a "valid start" will not be recalled to the start line;
- l.) The early starters will receive a time penalty in Transition 1;
- m.) An athlete who starts any time before the beginning of the "start procedure" or who starts in a wave they are not assigned to, will be disqualified;
- n.) Athletes who are late to their assigned wave must get approval of the Start TO to start;
- o.) The athlete start time will be the start time of the assigned wave, and no adjustment to his/her start time can be made.

4.8. Start Procedure (Rolling Start System)

- a.) This start system is appropriate for long distance events with mass participation. It may be used in draft illegal events, even if they are not long distance, or where the start conditions do not permit a wide space offering the athletes a safe start to the swim.
- b.) This system is only applicable to Age Group competitions.
- c.) There will not be a mass start.
- d.) The Start TO can interrupt the start procedure at any time.
- e.) The Start TO will determine the start time of any athlete in case of incidents at the start.
- f.) If one athlete has two or more start times recorded, the first one will be the valid start time

4.9. Equipment:

- a.) Swim cap:
 - (i) All athletes must wear the official event swim cap during the swim segment;
 - (ii) Swim caps are provided by ITU or the LOC;
 - (iii) If an athlete chooses to wear two caps, the official cap must be on the outside;
 - (iv) No sponsor logos are allowed on the swim cap other than prescribed by ITU/LOC;
 - (v) Athletes may not alter the swim caps in any manner;
 - (vi) Failure to wear the official swim cap, or altering the official swim cap, may result in a penalty up to and including disqualification.

b.) Trisuits:

- (i) Athletes must wear the approved trisuit for the non-wetsuit swims. If athletes choose to wear more than one trisuit, both have to comply with the specifications, and the external suit has to comply with the Uniform Rules. Uniforms cannot be removed during the entire competition, except in the middle and long distance events.
- (ii) Trisuits will not have any neoprene sections;
- (iii) If the suit has a zipper it will be located at the back (except for middle and long distance events) and will not be longer than 40 cm;
- (iv) When the use of wetsuits is forbidden, clothing covering any part of the arms below the shoulders and clothing covering any part of the legs below the knees is also forbidden (with the exceptions outlined at 2.8.c.(iii));
- (v) Printed logos may be located in the authorised spaces only.

c.) Wetsuits:

- (i) Wetsuits cannot exceed 5 mm thickness anywhere. If the wetsuit is made in two pieces, the combined thickness in the overlapping areas may not exceed the 5 mm thickness limit;
- (ii) Propulsion devices that create an advantage for the athlete, or a risk to others, are forbidden;
- (iii) The most external part of the wetsuits will fit to the athletes' body tightly while they are swimming;
- (iv) A wetsuit may cover any part of the body except the face, hands and feet;
- (v) There is no limitation regarding the length of the zipper.

d.) Illegal Equipment:

- (i) Athletes must not use or wear:
 - Artificial propulsion devices;
 - Flotation devices;
 - Gloves or socks;
 - Wetsuit bottoms when wetsuits are forbidden;
 - Wetsuits when they are forbidden;
 - Non-certified swimsuits;
 - Snorkels;
 - Official race numbers (in non wetsuit swim only).

5. CYCLING CONDUCT:

5.1. General Rules:

- a.) An athlete is not permitted to:
 - (i) Block other athletes;
 - (ii) Cycle with a bare torso;
 - (iii) Make forward progress without being in possession of the bike.
- b.) Dangerous Behaviour:
 - (i) Athletes must obey the specific traffic regulations for the event, unless a Technical Official advises otherwise;
 - (ii) Athletes leaving the field of play for safety reasons have to return to it without gaining any advantage. If an advantage is gained due to this action, the athlete will receive a time penalty to be served in the transition area for Age Groupers and at the run penalty box for everyone else.

5.2. Equipment:

- a.) In general, UCI rules, as of January 1st of the current year, will apply during competition and also during familiarisation sessions and official training:
 - (i) UCI road race rules for draft-legal triathlon and duathlon races;
 - (ii) UCI time trial rules for draft-illegal triathlon and duathlon races;
 - (iii) UCI Mountain Bike (MTB) rules for winter triathlon, cross triathlon and cross duathlon races.
- b.) The bicycle is a human powered vehicle with two wheels of equal diameter. The front wheel shall be steerable; the rear wheel shall be driven through a system comprising of pedals and a chain. Bicycles are referred to as bikes and will have the following characteristics:
 - (i) For draft-legal races. Elite, U23, Junior and Youth:
 - The frame of the bike shall be of a traditional pattern, i.e., built around a main triangle of three straight or tapered tubular elements, (which may be round, oval, flattened, teardrop shaped or otherwise in cross-section) such that the form of each element encloses a straight line. The elements of the frame shall be laid out such that the joining points shall follow the following pattern: the top tube connects the top of the head tube to the top of the seat tube; the seat tube (from which the seat post shall extend) shall connect to the bottom bracket shell; the down tube shall connect the bottom bracket shell to the bottom of the head tube. The rear triangles shall be formed by the chain stays, the seat stays and the seat tube with the seat stays anchored to the seat tube at points falling within the limits laid down for the slope of the top tube. The maximum height of the elements shall be 8 cm and the minimum thickness 2.5 cm. The minimum thickness shall be reduced to 1 cm for the chain stays and the seat stays. The minimum thickness of the elements of the front fork shall be 1 cm; these may be straight or curved. The maximum ratio of any two dimensions in a cross section of any tube is 1:3;
 - The bike will be no more than 185 cm long, and 50 cm wide;
 - The bike will measure between 24 cm and 30 cm from the ground to the center of the chain wheel axle;

- There will be a vertical line touching the front-most point of the saddle which will be no less than 5 cm for the men, and 2 cm for the women, behind a vertical line passing through the centre of the chain wheel axle, and an athlete must not have the capability of adjusting the saddle beyond these lines during competition. This rule will be applied only in U23 and Elite events. Exceptions to this rule may be requested from a panel composed by:
 - One person designated by ITU Technical Committee;
 - One person designated by ITU Coaches Committee;
 - One person designated by ITU Medical and Anti-doping Committee.
- There will be no less than 54 cm and no more than 65 cm between a vertical line passing through the centre of the chain wheel axle and a vertical line through the centre of the front wheel axle;
- Fairings are prohibited. Any device, added or blended into the structure, that is destined to decrease, or which has the effect of decreasing, resistance to air penetration or artificially to accelerate propulsion, such as a protective screen, fuselage form fairing or the like, shall be prohibited;
- Non-traditional or unusual bikes or equipment shall be illegal unless details have been submitted to the ITU Technical Committee for approval at least 7 days before the Event.
 Provided all other criteria of the ITU rules are met then full details of the equipment including images must be supplied to the ITU Technical Committee.
 A catalogue of all previously submitted equipment will be available on the website with confirmation as to whether it has been accepted or rejected.
 A form is available on the ITU website for athletes wishing to submit equipment for approval.
- Only logos of bicycle related products may appear on the athlete's bicycle;
- Logos may not interfere with, or hinder the placement of, the bicycle race number on the bicycle frame;
- Bike race number stickers, provided by ITU or the LOC, must be placed on the bike as instructed, without any alteration;
- Bikes provided with the UCI Road Race homologation label (Code RD) are always allowed in ITU draft legal events, even if they contravene any of the 5 first bullets in this 5.2 b) (i) insert.
- Bikes provided with the UCI Time Trial homologation label (Code TT) are forbidden unless they comply with the condition listed above.

(ii) For draft illegal events, and Age Group draft-legal events:

- The bike will be no more than 185 cm long, and 50 cm wide;
- The bike will measure between 24 cm and 30 cm from the ground to the center of the chain wheel axle;
- There will be no less than 54 cm and no more than 65 cm between a vertical line passing through the center of the chain wheel axle and a vertical line through the center of the front wheel axle;
- There will be a vertical line touching the front-most point of the saddle which will be no more than 5 cm in front of, and no more than 15 cm behind, a vertical line passing through the centre of the chain wheel axle, and an athlete must not have the capability of adjusting the saddle beyond these lines during competition;

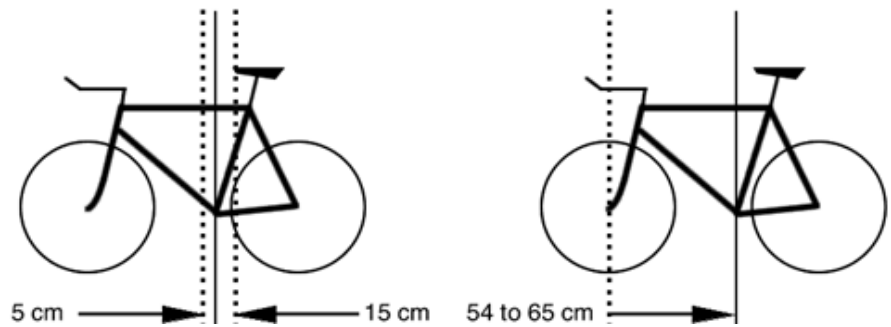

- The frame of the bike shall be of a traditional pattern, i.e., built around a closed frame of straight or tapered tubular elements, (which may be round, oval, flattened, teardrop shaped or otherwise in cross-section) Bikes built around a diamond shape (no saddle down tube) or with a rear triangle which does not connect at the top of the down tube/top tube section are considered acceptable.
- Non-traditional or unusual bikes or equipment shall be illegal unless details have been submitted to the ITU Technical Committee for approval at least 7 days before the Event. Provided all other criteria of the ITU rules are met then full details of the equipment including images must be supplied to the ITU Technical Committee. A catalogue of all previously submitted equipment will be available on the website with confirmation as to whether it has been accepted or rejected. A form is available on the ITU website for athletes wishing to submit equipment for approval.
- Only logos of bicycle related products may appear on the athlete's bicycle;
- Logos may not interfere with, or hinder the placement of, the bicycle race number on the bicycle frame;
- Bike race number stickers, provided by ITU or the LOC, must be placed on the bike as instructed, without any alteration;
- Bikes provided with the UCI Time Trial homologation label (Code TT) are always allowed in ITU draft illegal events, even if they contravene any of the 5 first bullets in this 5.2 b) (ii) insert.

c.) Wheels:

- (i) No wheel may contain any mechanisms, which are capable of accelerating it;
- (ii) Tubular tyres must be well glued, the levers of the quick releases must be closed tightly onto the hubs and wheels must be fixed properly onto the frame;
- (iii) There must be a brake on each wheel;
- (iv) Wheels can be replaced only at official wheel stations, where provided;
- (v) Technical Officials at the wheel station will give the proper wheel to the athlete. The athlete is responsible for replacing the wheel in the forks. Wheels designated specifically for other athletes or teams cannot be used;
- (vi) For Elite, U23, Junior and Youth draft-legal competitions, wheels must have the following characteristics:
 - A diameter between 70 cm maximum and 55 cm minimum, including the tyre;
 - Both wheels must be of equal diameter;
 - Wheels shall have at least 16 metal spokes;

- Spokes can be round, flattened or oval, provided their width does not exceed 2.4 mm;
 - The maximum rim dimension will be 25 mm. on each side;
 - Wheels not complying with the requirements above are allowed to be used if they are included in the UCI non-standard wheels list.
- (vii) For Age Group draft-legal competitions, wheels must have the following characteristics:
- Wheels shall have at least 12spokes;
 - Disc wheels are not allowed.
- (viii) For draft-illegal, competitions, covers are allowed on the rear wheel. However, this provision may be changed by the Technical Delegate in the interest of safety, i.e. high-winds.
- d.) Handlebars:
- (i) For Elite, U23, Junior and Youth draft-legal competitions, the following handlebar rules will apply:
- Only traditional drop handlebars are permitted. The handlebars must be plugged;
 - Clip-ons, including the bridge, must not exceed the foremost line of the brake levers;
 - Clip-ons must have a solid factory bridge or be touching each other;
 - Brake levers or gear levers must not be attached to the clip-ons The height difference between the highest point of the handlebar and the lowest inner part of the elbow rest cannot exceed 10 cm;
 - Water bottles and water bottle holders may not be mounted onto the handlebars or clip-on.
- (ii) For Age Group draft-legal competitions, the following handlebar rules will apply:
- Only traditional drop handlebars are permitted. The handlebars must be plugged;
 - Clip-ons are not allowed.
- (iii) For draft-illegal races, the following rules on handlebars apply:
- Only handlebars and clip-on bars not extending beyond the leading edge of the front wheel will be permitted. Clip-on bars in two pieces do not need to be bridged. All tube ends have to be plugged.
- e.) Helmets:
- (i) Helmets must be approved by a national accredited testing authority recognised by an NF affiliated with ITU;
- (ii) Helmet must be used in all official activities when the athlete rides the bike: competition, familiarisation and training sessions;
- (iii) An alteration to any part of the helmet, including the chin strap, or the omission of any part of the helmet, including an outer cloth cover, is prohibited;
- (iv) The helmet must be securely fastened at all times when the athlete is in possession of the bike, which means from the time they remove their bike from the rack at the start of the bike leg, until after they have placed their bike on the rack at the finish of the bike leg;

- (v) If an athlete moves the bike off the course for any reason, the athlete may not unfasten or remove the helmet until after he/she has moved outside the boundary of the bike course route and has dismounted the bike; and he/she must fasten the helmet securely on the head before returning onto the bike course or before remounting the bike;
 - (vi) Helmets must comply with the ITU Uniform Rules.
- f.) Platform Pedals:
- (i) Platform pedals are allowed, provided a quick-release mechanism is fitted to ensure the release of the feet in case of a fall.
- g.) Illegal Equipment:
- (i) Illegal equipment includes, but is not limited to:
 - Headphone(s), headset(s) or **technical earplug(s)**;
 - Glass containers;
 - Mobile phone(s) or any other electronic listening communication device;
 - Bike or parts of the bike not complying with these rules;
 - Uniform not complying with the ITU Uniform Rules.
 - Disk brakes, except for PT1 athletes.
 - h.) Any equipment or devices carried during the bike segment or added to the bike are subject to approval by the Race Referee before the race. Non approved devices are forbidden and may result in the disqualification of the athlete;
 - i.) For cameras and video cameras, in addition to requiring approval from the Race Referee, all the images and footage taken will be copied by ITU. The use of those images for commercial purpose is subject to approval by ITU.

5.3. Bike Check:

- a.) A **visual** bike check will take place upon Check-in to the transition area before the competition. Technical Officials will check that bikes comply with the ITU Competition Rules;
- b.) Athletes may request approval from the Race Referee during the Athletes' Briefing to allow them to make modifications, if necessary, to comply with the rules;
- c.) One athlete can only check one bike.

5.4. Overlapping:

- a.) Elite, U23, Junior and Youth, athletes who have been lapped during the bike segment will be withdrawn from the race by the **Technical Officials. Technical Officials may anticipate this decision, for safety reasons, if the athlete is closer than 100 meters ahead from the leader and the Technical Official is totally sure that the overlapping will happen.** This provision can be modified by the TD, following the procedure outlined in 1.5.

5.5. Drafting:

a.) General Guidelines:

- (i) There are two kinds of competitions, depending on the allowance of drafting:
 - Draft-legal races;
 - Draft-illegal races.
- (ii) The races will be draft-legal or illegal according to this table:

	Junior and Youth	U23	Elite	Age Group	Paratriathlon Elite and Open
TRIATHLON					
Team Relay	Legal	Legal	Legal		
Sprint Distance	Legal	Legal	Legal	Both options	Illegal
Standard Distance		Legal	Legal	Illegal	Illegal
Middle and Long Distance Triathlon			Illegal	Illegal	Illegal
DUATHLON					
Team Relay	Legal	Legal	Legal		
Sprint Distance	Legal	Legal	Legal	Both options	Illegal
Standard Distance		Legal	Legal	Illegal	Illegal
Long Distance			Illegal	Illegal	Illegal
AQUATHLON					
WINTER TRIATHLON (all distances)	Legal				
CROSS TRIATHLON AND DUATHLON (all distances)	Legal				

b.) Draft legal events:

- (i) It is forbidden to draft off a different gender athlete;
- (ii) It is forbidden to draft off a motorbike or vehicle.

c.) Draft-Illegal events:

- (i) It is forbidden to draft off another athlete or motor vehicle. Athletes must reject attempts by others to draft;
- (ii) An athlete is entitled to any position on the course, provided they get to that position first and without contacting others. When taking a position, an athlete must allow reasonable space for others to make normal movements without making contact. Adequate space must be available before passing;
- (iii) An athlete who approaches from any position to take advantage of the draft, bears responsibility for avoiding the draft;
- (iv) To draft is to enter the bicycle or vehicle drafting zone:
 - **Middle and long distance** draft zone: the bicycle draft zone will be 12 meters long measured from the leading edge of the front wheel. An athlete may enter the draft zone of another athlete, but must be seen to be progressing

- through that zone. A maximum of 25 seconds will be allowed to pass through the zone of another athlete;
- **Standard and shorter distance events** bicycle draft zone: the bicycle draft zone will be 10 meters long measured from the leading edge of the front wheel. An athlete may enter the draft zone of another athlete, but must be seen to be progressing through that zone. A maximum of 20 seconds will be allowed to pass through the zone of another athlete;
 - Motorbike draft zone: the draft zone behind a motorbike will be 12 meters long. This applies also for draft legal events;
 - Vehicle draft zone: The draft zone behind a vehicle will be 35 metres long and applies to every vehicle on the bike segment. This applies also for draft legal events.
- (v) Entry into the bicycle drafting zone: An athlete may enter a bike draft zone in the following circumstances:
- If the athlete enters the draft zone, and progresses through it within 20 seconds in the overtaking manoeuvre;
 - For safety reasons;
 - 100 metres before and after an aid station or transition area;
 - At an acute turn;
 - If the Technical Delegate excludes a section of the course because of narrow lanes, construction, detours, or for other safety reasons.
- (vi) Overtaking:
- An athlete is passed when another athlete's front wheel is ahead of theirs;
 - Once overtaken, an athlete must move out of the draft zone of the leading athlete within 5 seconds;
 - Athletes must keep to the side of the course and not create a blocking incident. Blocking is where an athlete who is behind cannot pass due to the leading athlete being poorly placed on the course;
 - The TD will instruct the athletes during the briefing on which side they must pass another athlete when mounted on their bicycle.
- (vii) See the diagrams below for events where left hand side road rules apply.

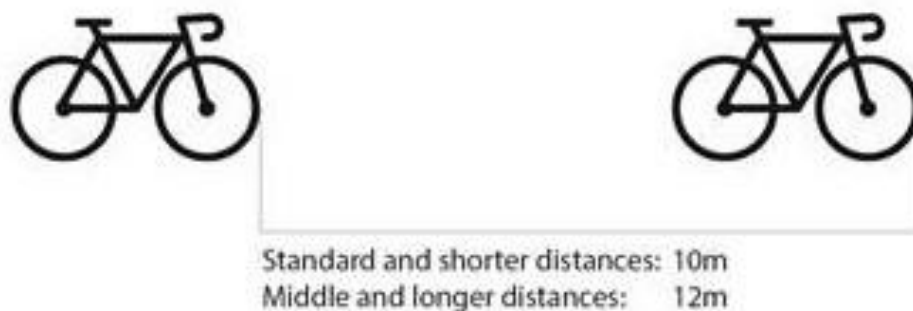

5.6. Penalties for Drafting:

- a.) It is forbidden to draft in a race declared as draft-illegal;
- b.) Technical Officials will notify the athletes who draft they are subject to a time penalty. This notification must be clear and unambiguous;

- c.) The athlete sanctioned has to stop in the next penalty box and must stay there for a specific time depending on the race distance. One minute for the sprint distance, two minutes for standard distance and five minutes for middle and long distance;
- d.) It is the athlete's responsibility to stop in the next penalty box. Failing to stop will result in a disqualification;
- e.) A second drafting offence will lead to a disqualification in standard distance events or shorter;
- f.) The third drafting offence will lead to disqualification for middle and long distance events.

5.7. Blocking:

- a.) Athletes must keep to the side of the course and not create a hazard by blocking other athletes on the course. Blocking is where an athlete who is behind an athlete cannot pass due to the leading athlete being poorly placed on the course. Athletes seen blocking by a Technical Official will incur a stop and go at the next bike penalty box.

Drafting

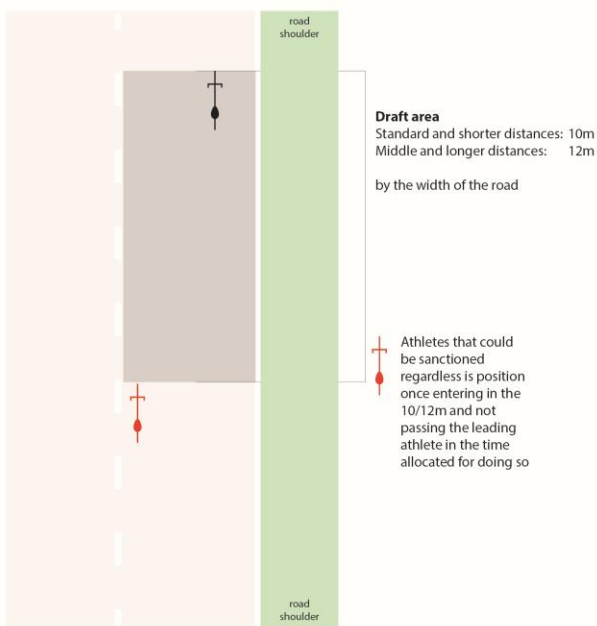

Blocking

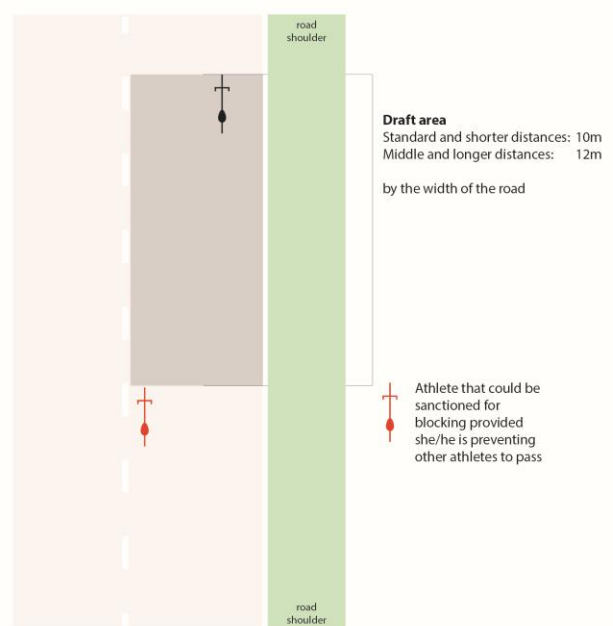

6. RUNNING CONDUCT:

6.1. General Rules:

- a.) The athletes will:
 - (i) Run or walk;
 - (ii) Wear the official race number (applicable always in the AG events. For other events, the TD can make it mandatory and athletes will be informed in the race briefing);
 - (iii) Not crawl;
 - (iv) Not run with a bare torso;
 - (v) Not run with a bike helmet on;
 - (vi) Not use posts, trees or other fixed elements to assist manoeuvring curves;
 - (vii) Not be accompanied by team members, team managers or other pacemakers on the course;
 - (viii) Not run together with other athlete/s who is/are one or more laps ahead. (Applicable only to Elite, U23, Junior, Youth athletes and Paratriathletes)

6.2. Finish Definition:

- a.) An athlete will be judged as finished, the moment any part of the torso crosses a vertical line extending from the leading edge of the finish line.

6.3. Safety Guidelines:

- a.) The responsibility of remaining on the course rests with the athlete. Any athlete, who appears to Technical or Medical Officials as presenting a danger to themselves or others, may be removed from the competition.

6.4. Illegal Equipment:

- a.) Headphone(s) and headset(s), mobile phones or any other electronic listening communication device;
- b.) Glass containers;
- c.) Uniform not complying with the ITU Uniform Rules.

7. TRANSITION AREA CONDUCT:

7.1. General Rules:

- a.) All athletes must have their helmet securely fastened from the time they remove their bike from the rack before the start of the bike leg, until after they have placed their bike on the rack after the finish of the bike leg;
- b.) Athletes must use only their designated bike rack and must rack their bike:
 - (i) For a traditional bike rack, the bike must be racked as follows:
 - For the first transition: in an upright position with the front of the saddle hooked over the horizontal bar so the front wheel is pointing to the middle of the transition lane. Technical officials may apply exceptions;
 - For the second transition: In any direction, with both sides of the handlebar, both brake levers or the saddle within 0,5 m of the rack number or name plate. The bike must be racked in a way that does not block or interfere with the progress of another athlete.
 - (ii) In case of an individual bike rack, the bike must be racked in the first transition by the rear wheel and in the second transition by either of the wheels.
- c.) Athletes must place within 0.5 m of the bin all equipment to be used at a later stage in the event. If a bin is not provided, the 0.5 m will be measured from the rack number or name plate. The bin, if provided, must be within 0.5 m from the rack number or name plate. All equipment already used must be deposited in the bin. A piece of equipment is considered deposited in the bin when one part of the equipment is inside the bin. Only equipment to be used during the competition can be left in transition. All other belongings and equipment are to be removed before race start;
- d.) If an athlete wishes to use the same shoes in a duathlon for the second run these do not have to be placed in the bin in transition one, however, only one pair of running shoes may be on the floor at any time during the race. Running shoes must be located within 0.5 m of the athlete's bin (rack number/name plate).
- e.) Bike shoes, glasses, helmet, and other bike equipment can be placed on the bike;
- f.) Athletes must not impede the progress of other athletes in the transition area;
- g.) Athletes must not interfere with another athlete's equipment in the transition area;
- h.) Cycling is not permitted inside the transition area, except during the cycling segment. Athletes must mount their bicycles after the mount line by having one complete foot contact with the ground after the mount line. Athletes must dismount their bicycles before the dismount line by having one complete foot contact with the ground before the dismount line. While in the transition area (before the mount line and after the dismount line) the bike can be pushed only by the athlete's hands. If during the mount or dismount manoeuvre, the athlete loses their shoe(s) or other equipment, they will be collected by the TOs and no penalty will be applied. Mount and dismount lines are part of the transition area;
- i.) Nudity or indecent exposure is forbidden;
- j.) Athletes can not stop in the flow zones of the transition area;
- k.) Marking positions in the transition area is forbidden. Marks, towels and objects used for marking purposes will be removed and the athletes will not be notified;
- l.) The helmet strap must remain unfastened in the transition area while the athlete is completing the first segment.

8. COMPETITION CATEGORIES:

8.1. World Championships:

a.) ITU may organise World Championships in the distances and categories shown in this chart:

	Elite	U23	Junior	Age Group	Paratriathlon
TRIATHLON					
Team Relay	Yes	(U23/Jr combined) Yes			
Sprint Distance	Yes	Yes	Yes	Yes	Yes
Standard Distance	Yes	Yes		Yes	Yes
Middle and Long Distance	Yes			Yes	Yes
DUATHLON					
Team Relay	Yes		Yes		
Sprint Distance	Yes	Yes	Yes	Yes	Yes
Standard Distance	Yes	Yes		Yes	Yes
Long Distance	Yes			Yes	Yes
AQUATHLON					
Standard Distance	Yes	Yes	Yes	Yes	Yes
Long Distance	Yes			Yes	Yes
WINTER TRIATHLON					
Team Relay	Yes		Yes		
Sprint Distance			Yes	Yes	Yes
Standard Distance	Yes	Yes			
CROSS TRIATHLON AND DUATHLON					
Team Relay	Yes		Yes		
Sprint Distance			Yes		Yes
Standard Distance	Yes	Yes		Yes	Yes

b.) NFs and Continental Confederations should include each of these categories in their National and Continental Championships.

8.2. Paratriathlon:

a.) All World Triathlon Series events and Triathlon World Cup events, hosting an Age Group competition, should host a paratriathlon race as part of the mass participation event. The Paratriathlon World Championship and the Paratriathlon Continental Championships in all disciplines must be hosted as a separate event from the Age Group competitions. In all other events, the Technical Delegate and the LOC will decide on the schedule of the paratriathlon competition.

9. PRIZES AND AWARDS:

9.1. Prize Money:

a.) General Rules:

- (i) Prize money for the ITU events shall be distributed equally between men and women in both amount and depth, according to the ITU Prize Money Percentage Breakdown, as outlined in Appendix H.

9.2. Primes:

a.) Primes may be offered at ITU events. Primes are payable to the athletes as follows:

- (i) Be in first position through the prime line;
- (ii) Finish the competition;
- (iii) There is no limit to the number of primes an athlete can win in a race;
- (iv) If the prime is not collected by an athlete due to not finishing, the prime remains with ITU to be used at its discretion;
- (v) The amount of the primes will be announced at the Athletes' Briefing of each competition and will be distributed equally in amount to men and women.

9.3. Awards:

- a.) Athletes or team members who place first, second or third at any ITU event will be awarded an official ITU medal (gold, silver, bronze);
- b.) In addition, teams may receive a trophy for first, second and third positions.

9.4. Prizes, Points and Awards in combined events/categories:

- a.) In case of events which take place together or different categories competing together in the same wave, the awards, prize money and points will be distributed as follows:

Events taking place together:	Awards (medals) to:	Prize money to:	Points to:
Elite and U23	- Elite awards for all - U23 awards for U23	- Overall	- Overall
Elite, U23 and Junior	- Elite awards for all - U23 awards for U23 - Junior awards for Junior	- Overall	- Overall
U23 and Junior	- U23 awards for U23 - Junior awards for Junior	- Overall	- Overall
All categories	- Elite awards for all - Categories awards per categories	- Overall	- Overall
Triathlon Continental Championships with athletes from other continents	- Award for the athletes from the continent	- All are eligible	- Athletes from the continent
Multisport Continental Championships with athletes from other continents	- Award for the athletes from the continent	- All are eligible	- Overall
Continental Cups	- Overall	- Overall	- ITU points: overall - Continental points: Athletes from the continent

- b.) Athletes from other continents can participate in Continental Championships provided that the race is not full with the athletes from the host continent. In this case, points and medals are going to athletes from the host continent, but prize money is distributed to the athletes in the overall results. The exceptions to this paragraph are the Duathlon and Long distance Triathlon Continental Championships that are part of the World Series as well: in this case points are distributed to the overall results.

10. EVENTS:

10.1. Wave starts:

- a.) To ensure the safety of the athletes, there are limits on the quantity of athletes starting at the same time:

	WTS	WTS GF	Other Standard and shorter distances triathlons	Middle and Long Distance Triathlon. All events (*)	Cross Triathlon. All events	Duathlon. All events
Elite	65	75	75	100	100	100
U23	n/a	75	75	n/a	100	100
Junior	n/a	80	75	n/a	100	100
Youth	n/a	n/a	75	n/a	n/a	n/a
Elite Paratriathlon	n/a	100	70 (**)	80	80	80
Open Paratriathlon	n/a	100	n/a	n/a	n/a	n/a
AG	n/a	200	200	500	500	500

(*) Long distance triathlon may have larger start groups if they are in water start events and after TD approval.

(**) 70 athletes for a Paratriathlon Continental Championships and 60 athletes for a World Paratriathlon event

- (i) All Elite/U23/Junior triathlon events in standard and sprint distance, except the World Triathlon Series: 75 athletes is the maximum number of athletes;
 - (ii) World Triathlon Series Events, except the Grand Final: 65 athletes is the maximum number of athletes;
 - (iii) World Triathlon Series Grand Final: 75 athletes is the maximum number of athletes.
- b.) Athletes from the same age group can be divided in two or more wave starts provided:
- (i) Both/all waves will have the similar number of athletes assigned;
 - (ii) Athletes from the same NF will be split in two groups randomly, assigning the similar number to each of the waves;
 - (iii) NFs with only one athlete will be entered to one or the other wave, in order to keep the numbers balanced. The same principle will apply to the excess resulting from NFs with odd number of athletes;
 - (iv) The champion will be the athlete with quickest time, no matter in which wave he/she is starting in;
 - (v) The result list of the Age Groups affected will contain the athletes of both waves sorted by times;
 - (vi) The waves containing athletes from the same age group will be scheduled one immediately after the other;
 - (vii) These waves will not include athletes from a different Age Group.

10.2. Swim:

- a.) The TD may modify the distance of the swim segment or even cancel the swim, depending on the speed of the current.
- b.) Water quality:
- (i) A sample of a mixture of the water collected from three different locations on the swim course will be analysed and the results will determine if the swim can take place. The swim will be allowed if the following values are below the level of tolerance in the different types of water:
- Sea and transition water:
 - PH between 6 and 9;
 - Entero-cocci not more than 100 per 100 ml (ufc/100ml);
 - Escherichiacoli E. Coli not more than 250 per 100 ml (ufc/100ml).
 - Inland water:
 - PH between 6 and 9;
 - Entero-cocci not more than 200 per 100 ml (ufc/100ml);
 - Escherichiacoli E. Coli not more than 500 per 100 ml (ufc/100ml);
 - The presence of Blue-Green Algal blooms/scum (cyanobacteria) not more than 100.000 cells/ml.
 - All units have to be ufc/100 ml or nmp/100 ml. (ufc→Colony Forming Units; nmp→ Most Probable Number)
- (ii) If the water quality test shows values out of the tolerance limits as indicated above, the swim will be cancelled, unless the ITU Medical and Anti-doping Committee permits.

10.3. Transition:

- a.) The TD will determine the position of the mount and dismount lines. Both lines will be considered as part of the transition area.

10.4. Bike:

- a.) A 10 % tolerance margin will be accepted for the distance of the bike segment provided that it has been approved by the TD. In the middle and long distance events, this tolerance is limited to 5%;
- b.) There must be a minimum number of penalty boxes as follows:
- Standard distance or shorter events: one every 10 km;
 - Middle and long distance events: one every 30 km.

10.5. Support team:

- a.) NF Quota: Every NF has a support team quota according to these charts:

- (i) Elite events:

Athletes	1 to 3	4 to 6	7 or more
Coaches	2	3	4

- (ii) U23 events (U23 not mixed with other categories):

Athletes	1 to 6	7 or more
Coaches	2	3

- (iii) Junior events:

Athletes	1 to 6	7 or more
Coaches	2	3

(iv) Youth events:

Athletes	1 to 6	7 or more
Coaches	2	3

(v) Elite Paratriathlon Events:

Athletes	1 to 3	4 to 6	7 or more
Coaches	2	3	4

(vi) Open Paratriathlon Events:

Athletes	1 to 3	4 to 6	7 or more
Coaches	2	3	4

(vii) Age group events:

Athletes	1 to 50	51 to 100	101 to 150	More than 151
Coaches	2	4	6	8

(viii) Delegation support:

Athletes	1 to 50	51 to 100	101 to 150	More than 151
Bike mechanic/Ski man	1	2	3	3
Medical	1	1	1	1
NF Representatives	2	4	6	8

- b.) All the personnel registered as part of the support team will receive an accreditation with access according to their role;
- c.) NFs are responsible for entering their support personnel in the ITU online entry system. ITU will approve the support personnel according to the quota seven days prior to the event. No additions will be admitted after this deadline.

10.6. Start times:

a.) The minimum time difference between waves will be:

	Inter gender start time difference (1)	Elite/AG start time difference (2)
Continental Cup Sprint	45 m	1 h
Continental Cup Standard	1 h 30 m	2 h
World Cup Sprint	1 h 45 m	1 h 30 m
World Cup Standard	2 h 45 m	2 h 30 m
World Triathlon Series Sprint	1 h 45 m	1 h 45 m
World Triathlon Series Standard	2 h 45 m	2 h 45 m
Duathlon Standard Distance	1 h 30 m	2 h 30 m
Triathlon and Duathlon Middle and Long Distance	5 m	5 m
3x Team Relay	1 h 45 m	n/a

(1) This will be applicable whether the men or the women's event starts first.

(2) This will be applicable for AG waves starting after the Elite events. Elite events starting after the AG Events will only start once the AG Events have finished.

- b.) The TD can decide to reduce the above indicated differences in Continental Cup and Duathlon standard distance events provided that the men and the women will not be on the bike segment simultaneously;

- c.) The TD can decide to reduce the above indicated differences in Continental Cups and Duathlon standard distance events to a minimum of five minutes if one of the events has fewer than 10 athletes competing, and enough officials to control any potential drafting between male and female athletes;
- d.) The TD can also require different start times by asking for a specific regulation, as indicated under section 1.6;
- e.) Events not included in the previous chart will need the approval of the TD prior to publishing the start times.

10.7. Modified events:

- a.) When a race cannot be held in the original format due to force majeure, all the points for all the rankings related, including Olympic Qualification List points, will be reduced depending on the final conditions under which the event took place:
 - (i) If the event remains as a triathlon **or the multisport originally planned**, but any of all of the segments are shortened according to the ITU Competition Rules, 100 % of the points will be awarded;
 - (ii) If the event becomes another ITU multisport race according to the ITU Competition Rules in terms of distances and conditions, 75 % of the points will be awarded;
 - (iii) **If a triathlon event becomes a duathlon and the swim is replaced by a running segment with similar duration of the cancelled swim, 75% of the points will be awarded**
 - (iv) If the event becomes another ITU multisport race with deviations from the ITU Competition Rules in terms of distances and conditions, 50 % of the points will be awarded.

11. TECHNICAL OFFICIALS:

11.1. General:

- a.) The duties of the Technical Officials are to conduct the competition are in accordance with the ITU Competition Rules;
- b.) ITU Technical officials are:
 - (i) Technical Officials;
 - (ii) Paratriathlon Specific Technical Officials;
 - (iii) Competition Jury members.
- c.) To hold a race under these Competition Rules, it is necessary to have the presence of:
 - (i) A Technical Delegate, and
 - (ii) A Race Referee.

11.2. ITU Technical Officials:

- a.) The Technical Officials at all ITU races are:
 - (i) The ITU Technical Delegate (TD) ensures all aspects of the ITU Competition Rules and ITU Event Organisers' Manual are fulfilled. LOCs will modify the race conditions, as per the indications of the TD at any time. Accredited coaches will be informed about the modifications;
 - (ii) The Assistant Technical Delegate (ATD) assists the TD with his/her duties;
 - (iii) The Race Referee checks the certification of the Technical Officials, makes the results official by signing them and makes final judgments on rule violations;
 - (iv) The Chief Race Official (CRO) assigns and monitors the work of all Technical Officials;
 - (v) Technical Officials are assigned to Registration, Start, Finish, Transition Area(s), Pre-transition Area, Swim, Swim exit, Bike, Run, Wheel Stations, Prime Lines, Aid Stations, Technology, Penalty Boxes, Lap Counter, Protocol, Race Control Office, Video Review, and Vehicle Control. An adequate number of Technical Officials will be assigned to each area and will be responsible for the enforcement of ITU Competition Rules within their assigned jurisdiction. A Technical Official may be assigned in more than one position. Additional positions may be created if necessary;
 - (vi) The Competition Jury is appointed by the Technical Delegate;
 - (vii) The ITU Medical Delegate, appointed by the ITU Medical and Anti-doping Committee, is responsible for all medical and anti-doping issues on behalf of ITU.

11.3. Paratriathlon Specific Technical Officials:

- a.) The Chief Classifier is a classifier responsible for the direction, administration, co-ordination and implementation of classification matters;
- b.) Classifiers will be responsible for determining the Sport Class and Sport Class Status of the Paratriathletes from PT₁ to PT₄ Paratriathletes;
- c.) Classifiers certified by the International Blind Sports Federation and International Paralympic Committee will be responsible to determine the sport class and sport class status of the PT₅ Paratriathletes;
- d.) ITU Paratriathlon Classification Rules are included in Appendix G.

11.4. Competition Jury:

- a.) The ITU Technical Delegate will appoint the members of the Competition Jury as follows:
- (i) For Olympic Games and the Elite races of the World Triathlon Series Grand Final the Competition Jury consists of five people being selected from:
 - The Technical Delegate, who chairs the Competition Jury;
 - A member of the ITU Executive Board;
 - A representative of the host NF;
 - A representative from the ITU Technical Committee;
 - A representative from the ITU Medical and Anti-doping Committee.
 - (ii) For all the other ITU events and other Games that do not include the Olympic Games, the Competition Jury consists of three people being selected from:
 - The Technical Delegate, who chairs the Competition Jury;
 - A member of the ITU Executive Board or any Committees or Commissions, or if none are present, a member of the Continental Confederation's Executive Board or any Committees or Commission, or staff liaisons, or if none are present, a representative from the host NF;
 - A representative from the host NF.
 - (iii) The Competition Jury can invite experts to the hearing, whereby they may have voice but no vote.
- b.) Being a member of the Competition Jury in one event is not compatible with:
- (i) Being a TO in the same event other than the Technical Delegate;
 - (ii) Being an accredited coach in the same event;
 - (iii) Being an athlete competing in the same event.
- c.) Duties of the Competition Jury:
- (i) The Competition Jury rules on all appeals and all protests;
 - (ii) The Competition Jury has the authority to modify the competition results as a consequence of its decision on the appeal or protest;
 - (iii) The Competition Jury must be available starting before the Athletes' Briefing until after the end of competition;
 - (iv) The Competition Jury Chair is responsible for filing a written statement on all appeals and decisions reached.
- d.) Competition Jury meetings schedule:
- (i) Competition Jury will meet, at a minimum:
 - After the race briefing;
 - One hour before the start of the event;
 - After the last finisher.
 - (ii) Additionally, in the Age Group events, the Competition Jury will meet, at a minimum:
 - After the first finisher;
 - After the finish of the first half of the field.

e.) Competition Jury Integrity:

(i) The Competition Jury observes the following principles:

- Give equal weight to the evidence and testimony provided by all;
- Recognize that honest testimony can vary and be in conflict as a result of personal observation or recollection;
- Have an openminded approach until all evidence has been submitted;
- Recognise an athlete is innocent until the alleged violation has been established to the complete satisfaction of the Competition Jury.

(ii) Conflict of interest:

- The Chair of the Competition Jury decides if any member has a conflict of interest;
- In case of a conflict of interest, the Chair of the Competition Jury has to replace the member who has the conflict of interest, at his/her discretion. The Competition Jury will remain with the same number of members that it originally had;
- The Chair of the Competition Jury is deemed not to have a conflict of interest.

11.5. Technology Tools:

- a.) ITU Officials may use any kind of electric, electronic, magnetic, or other technological support to acquire data or evidence on rule infractions.

11.6. Volunteer Certification:

- a.) All volunteers, who are assigned to areas of responsibility on the Field of Play (FOP), must be educated to ITU's minimum standard. Education kits obtained from ITU will cover key areas of FOP responsibility.

12. PROTESTS:

12.1. General:

- a.) A protest is against the conduct of an athlete, Technical Official, or the conditions of the competition. An athlete or an NF designate may file a protest with the Race Referee provided the protest has not been previously observed by the Technical Officials and ruled upon by the Race Referee.

12.2. Protests Concerning Eligibility:

- a.) Protests concerning the eligibility of an athlete shall be made to the Race Referee before the Athletes' Briefing. The Competition Jury will decide on this in a meeting scheduled immediately after the Athletes' Briefing.

12.3. Protests Concerning the Course:

- a.) Protests concerning the safety of the course or its variance to the regulations must be made to the Race Referee no later than twenty-four (24) hours before the start of the race.

12.4. Protests Concerning the Race:

- a.) An athlete, who protests against another athlete or Technical Official, must do so to the Race Referee within five (5) minutes of his/her finish time. In case of a protest that is initiated within this period, the time limit will be extended by fifteen (15) more minutes.

12.5. Protests Concerning Equipment:

- a.) Protests concerning an athlete's equipment, which infringes on the conditions set out in the ITU Competition Rules, must be delivered to the Race Referee within five (5) minutes of his/her finish time. In case of a protest that is initiated within this period, the time limit will be extended by fifteen (15) more minutes.

12.6. Protests Concerning Timing and Results:

- a.) Protests concerning typographical errors in the results, which are not reflecting the decisions made by the Race Referee or the Competition Jury, may be delivered in writing by the athlete or the NF to the ITU TD within thirty (30) days after the competition.

12.7. Contents of a Protest:

- a.) The protest related to 12.1, 12.2, 12.3, 12.4 and 12.5 must be accompanied by a deposit of \$50 USD, or its equivalent, and will be refunded if the protest is successful. If the protest is denied, there will be no refund and the money will be retained by ITU. Protest forms may be obtained from the Race Referee. A sample of the protest form is included in Appendix B:
 - (i) Information to be included:
 - The alleged rule violated;
 - The location and approximate time of the alleged violation;
 - Persons involved in the alleged violation;
 - A statement, including a diagram of the alleged violation, if possible;
 - The names of witnesses who observed the alleged violation.

12.8. Protest Procedures:

- a.) The following procedure will be followed in the event of a protest:
- (i) Protests will be filed with the Race Referee, signed by the protester, within the time limits specified above;
 - (ii) The Race Referee will announce on the notice board in the finish area that a protest has been filed;
 - (iii) The protester and the accused and/or their national coach or representative must be present. If the protester does not attend, the protest hearing may be postponed or cancelled. The Competition Jury will determine if absence from the hearing is valid;
 - (iv) Failure of any party to attend the hearing may justify the Competition Jury in making a decision without them;
 - (v) A representative for either the protester or the accused may be designated to appear if approved by the Chair of the Competition Jury;
 - (vi) The hearing will not be open to the public;
 - (vii) The Competition Jury Chair will explain the process and everyone's rights;
 - (viii) The Competition Jury Chair will read the protest;
 - (ix) The protester and the accused will be given adequate time to give their accounts of the incident;
 - (x) Witnesses (up to two each) may speak for up to three (3) minutes each;
 - (xi) The Competition Jury will hear the evidence and render a decision, by simple majority;
 - (xii) The decision will be posted immediately and delivered in writing to the parties upon request;
 - (xiii) The Competition Jury will produce minutes of the meeting, including the Competition Jury's decision, which must be approved by all members of the Competition Jury, by the end of the meeting. The minutes will be submitted to ITU.

13. APPEALS:

13.1. Appeal Jurisdiction:

- a.) An appeal is a request for a review of a decision made by the Race Referee (Level 1), the Competition Jury or any ITU panel, **excluding the appeal panel** (Level 2) and **the ITU Medical and Anti-doping Committee solely with regards to eligibility (Level 3)** or the **ITU Arbitration Tribunal** (Level 3). A sample of the Appeal Form is available in Appendix C.

13.2. Levels of Appeal:

- a.) The following procedure will be followed in the event of a Level 1 Appeal:
- (i) A Representative of an NF or an athlete may appeal the decision of the Race Referee to the Competition Jury. The appropriate appeal form can be obtained from the Race Referee;
 - (ii) Appeals will be filed in writing to the Race Referee, signed by the appellant and will be accompanied by a fee of \$50 USD or equivalent. It will be refunded if the appeal is successful. If the appeal is denied, there will be no refund and the money will be retained by ITU;
 - (iii) An athlete or NF representative who appeals a Race Referee's decision must do so to the Race Referee within five (5) minutes of his/her finish time. In case of a protest that is initiated within this period, the time limit will be extended by fifteen (15) more minutes for team competitions, this time limit is related to the final team time;
 - (iv) The Race Referee will post information on the notice board that an appeal has been filed;
 - (v) An appeal will contain:
 - Competition name, location, date;
 - Appellant's name, address, phone, fax, email;
 - Witness(es) name(s);
 - Alleged decision appealed;
 - Facts of the violation;
 - Rationale/summary of appeal.
 - (vi) The appellant and the accused and/or their national representative must be present. If the appellant does not attend, the appeals hearing may be postponed or cancelled. The Competition Jury will determine if absence from the hearing is valid;
 - (vii) Failure of any party to attend the hearing may justify the Competition Jury in making a decision without them;
 - (viii) A representative for either the appellant or the accused may be designated to appear if approved by the Chair of the Competition Jury;
 - (ix) The hearing will not be open to the public;
 - (x) The Competition Jury Chair will explain the process and everyone's rights;
 - (xi) The Competition Jury Chair will read the appeal;
 - (xii) The appellant and the accused will be given adequate time to give their accounts of the incident;
 - (xiii) Witnesses (up to two each) may speak for up to three (3) minutes each;
 - (xiv) The Competition Jury will hear the evidence and render a decision, by simple majority;
 - (xv) The decision will be posted immediately and delivered in writing to the parties upon request;
 - (xvi) The Competition Jury will produce minutes of the meeting, including the Competition Jury's decision, which must be approved by all members of the Competition Jury, by the end of the meeting. The minutes will be submitted to ITU.

- b.) The following procedure will be followed in the event of a Level 2 Appeal:
- (i) Decisions from any Competition Jury and any ITU panel (except the ITU AD Hearing Panel) may be appealed to the ITU Arbitration Tribunal;
 - (ii) Only appeals supported by NF will be admitted;
 - (iii) Appeals may be submitted up to thirty natural days after the Competition Jury met or within thirty natural days from the Competition Jury or Panel decision;
 - (iv) Appeals will be submitted in writing to the ITU Secretary General and will be accompanied by a deposit of \$ 500 USD. It will only be refunded if the appeal is successful.;
 - (v) Level 2 appeal decisions may be appealed to CAS (Level 3 of Appeal)
- c.) Level 3: The decision of the ITU Arbitration Tribunal or of the ITU Medical and Anti-doping Committee (solely with regards to eligibility) may be appealed, as a final and last resort, to the Court of Arbitration for Sport (CAS), to the exclusion of any recourse to ordinary courts, within thirty natural days from the decision of ITU Arbitration Tribunal. Any decision taken by the said court (CAS) shall be without appeal and shall be binding on the parties concerned.

ITU COMPETITION RULES: SPECIFIC DISCIPLINE COMPETITION RULES



14. INDOOR TRIATHLON:

14.1. Definition:

- a.) An Indoor triathlon consists of a triathlon, which takes place in a closed space such as a sports pavillion, which has a swimming pool, a cycling track and a running track.

14.2. Swim:

- a.) Two athletes are allowed per lane of 2.5 metres wide.

14.3. Transition area:

- a.) Following the swim there will be a ten (10) second "neutralized" time period that is compulsory for all athletes. The purpose of this period is to sponge excess water off the athletes. Water on the track makes it very slippery and dangerous for all athletes. Not complying with this rule will result in disqualification.

14.4. Bike Segment:

- a.) The lapped athletes will be not removed from the race;
- b.) Athletes can draft from others who are on a different lap.

15. MIDDLE AND LONG DISTANCE EVENTS:

15.1. Outside Assistance:

- a.) Medical assistance and food and liquid are permitted at LOC aid stations or at coaches' stations. All other outside assistance is prohibited.

15.2. Medical Guidelines:

- a.) Specific Medical Guidelines, including "hot weather" guidelines and medical evacuation plans will be developed by the Race Medical Director in conjunction with the ITU Medical Delegate.

15.3. Distances:

- a.) The course should have demanding hills and challenging technical aspects. A 5% tolerance margin will be accepted for the distance of the bike course, provided it has been approved by the Technical Delegate.

15.4. Penalties:

- a.) A 5-minute penalty will be imposed for violation of the drafting rule, which must be served in the next penalty box;
- b.) If an athlete receives three drafting penalties, he/she will be disqualified.

15.5. Coaches Stations:

- a.) Coaches will have a designated space available on the bike and run segments in order to supply athletes with their own food and beverages.

15.6. Transition area:

- a.) In the transition area, Technical Officials or LOC Staff may assist athletes by receiving and placing their bikes and handing out their equipment. This service must be equal for all athletes;
- b.) Athletes are allowed to replace their uniforms in the transition area. If the athlete needs to become nude to do it, this action needs to be done inside the tent provided by the LOC for this purpose. All the uniforms used by the athlete have to comply with the ITU Competition Rules.

15.7. Uniform:

- a.) Front zipper is allowed. The maximum length is 40 cm.

16. TEAM AND RELAY EVENTS:

16.1. Types of Events:

- a.) ITU may organise Team Events in the distances and categories shown in this table:

	Type of competition
Triathlon	3 x Same Gender / 4 x Mixed
Triathlon LD	Adding 3 best times
Duathlon	3 x Same Gender / 4 x Mixed
Duathlon LD	Adding 3 best times
Winter	3 x Same Gender / 4 x Mixed
Cross Triathlon	3 x Same Gender / 4 x Mixed
Cross Duathlon	3 x Same Gender / 4 x Mixed
Corporate Triathlon	Corporate

16.2. Continental Championships and National Federation Events:

- a.) Continental Confederations and National Federations should include each of these team competitions in their championships.

16.3. Definitions:

- a.) **Mixed relay:** A team is composed of 4 athletes: 2 men and 2 women, who will compete in the following order: woman, man, woman, man. Each of them will cover a complete triathlon, cross triathlon, duathlon, cross duathlon or winter triathlon. The total time for the team is from the start of the 1st team member to the finish of the 4th athlete. Time is continuous and the watch does not stop between athletes;
- b.) **3x relay:** A team is composed of 3 athletes of same gender. Each of them will cover a complete triathlon, cross triathlon, duathlon, cross duathlon or winter triathlon. The total time for the team is from the start of the 1st team member to the finish of the 3rd athlete. Time is continuous and the watch does not stop between athletes;
- c.) **Corporate:** A team is composed of 3 athletes regardless of gender. The first athlete will cover the swim segment, the second one the bike segment and the third one the run segment. The total time for the team is from the start of the 1st team member to the finish of the 3rd athlete. Time is continuous and the watch does not stop between athletes;
- d.) **Team competition based on the individual results:** The total team time is the addition of the 3 best times of the athletes from the same nation and gender. In case of a tie, the time of the third team member will determine the team result;

16.4. Results:

- a.) Each NF can enter more than one team, but only the team with the best finishing position will be listed in the results and eligible for awards (medals) and prize money.

16.5. Eligibility:

- a.) The general eligibility rules apply. The minimum age is 15 years.
- b.) Athletes who are competing under ITU flag are not eligible to be included in any team

16.6. Uniform:

- a.) The ITU Uniform Rules apply. All members of a team must wear the same country uniform.

16.7. Team Relay Briefing:

- a.) Team relay briefing. A briefing for the coaches will be conducted the day before the event.

16.8. Team Composition:

- a.) The team coach will declare the team composition at the team relay briefing. All team compositions will be published after the team relay briefing;
- b.) Two hours before the race start, the coach can communicate a different team composition to the TD, otherwise the team composition communicated at the team relay briefing will remain in force.

16.9. Race Day Check-In:

- a.) All the team members must check in together.

16.10. Relay Exchange:

- a.) The relay exchange from one team member to another will take place inside the exchange zone, which is 15 metres long;
- b.) The exchange is completed by the in-coming athlete, using their hand to contact the body of the out-going athlete within the relay zone;
- c.) If the exchange occurs unintentionally outside the exchange zone, the team will receive a penalty of 10 seconds, which must be served in the penalty box. If the relay Exchange was done intentionally outside the relay zone, the team will be disqualified.
- d.) If the exchange is not completed, the team will be disqualified;
- e.) Prior to the relay exchange, the athletes will wait in a pre-relay exchange area until the Technical Official tells them to enter the exchange zone.

16.11. Penalty Box:

- a.) Infractions due to starting before the official start time and leaving the helmet strap fastened in transition area infractions will be served by the athlete who infringes the rule;
- b.) All time penalties will be penalised with 10 seconds and are to be served at the penalty box. These penalties can be served by any team member currently competing on the field of play.

16.12. Finish:

- a.) Only the last team member is allowed to cross the finish line.

17. PARATRIATHLON:

17.1. General:

- a.) Paratriathlon, as per the ITU Constitution, is governed by the ITU Competition Rules. This section contains the rules which affect only paratriathlon.

17.2. Paratriathlon Sport Classes:

- a.) ITU Paratriathlon has implemented an evidence-based classification system to group impairments into sport classes according to the extent of activity limitation they cause the athlete when performing in the sport of paratriathlon;
- b.) There are five sport classes, as defined in Appendix G:
 - (i) PT₁: Wheelchair users. Athletes must use a recumbent handcycle on the bike course and a racing wheelchair on the run segment;
 - (ii) PT₂: Severe impairments. In both bike and run segments, amputee athletes may use approved prosthesis or other supportive devices;
 - (iii) PT₃: Moderate impairments. In both bike and run segments, the athlete may use approved prosthesis or other supportive devices;
 - (iv) PT₄: Mild Impairments. In both bike and run segments, the athlete may use approved prosthesis or other supportive devices;
 - (i) PT₅: Total or Partial visual Impairment (IBSA/IPC defined sub-classes B₁, B₂, and B₃): Includes athletes who are totally blind, from no light perception in either eye, to some light perception (B₁) and partially sighted athletes (B₂-B₃). One guide is mandatory throughout the race. Must ride a tandem during the bike segment.

17.3. Classification:

- a.) Paratriathlon Classification Rules and Regulations can be found in Appendix G;
- b.) All Paratriathletes competing at an ITU sanctioned competition must have an international paratriathlon classification to ensure they meet the minimal eligibility criteria for competition and are assigned an appropriate sport class. Paratriathletes requiring classification will need to:
 - (i) be available to attend an International Classification appointment with an ITU designated Classification Panel prior to the competition;
 - (ii) provide, at time of classification, the "ITU PI Medical Diagnostics Form" or "ITU VI Medical Diagnostics Form" signed by the appropriate medical personnel, a passport sized photo and any other relevant medical documentation.
- c.) Paratriathletes competing at an ITU event, where classification is not available, will be informed through their National Federation to submit specific medical documentation to ITU, no later than 4 weeks before competition, so that a provisional classification can be assigned to them;
- d.) When an athlete's sport class changes, a revision of the past results can be requested. ITU will study each request on a case to case basis and decide whether the relevant race results need to be modified.

17.4. Eligible classes and Race formats:

- a.) All Paratriathletes are allowed to compete in triathlon, duathlon and aquathlon events. Only Paratriathletes from sport classes PT₂, PT₃, and PT₄ are allowed to compete in winter triathlon, cross triathlon and cross duathlon events;

- b.) All Paratriathletes may start all together, or grouped in waves. Athletes from the same sport class and gender must start in the same wave;
- c.) The Paratriathlon World Championships, the Paratriathlon Continental Championships and the World Paratriathlon Events taking place on Sprint distance will have a time limit of 2 hours;
- d.) In a Duathlon event, a paratriathlon race should be organised at least in two wave starts with a difference of at least one (1) minute. PT1 athletes should start in the first wave and the rest of the athletes in the second wave;
- e.) At the discretion of the technical delegate the competition format may be changed;
- f.) Sport classes may be divided in sub classes. Since 2014 PT5 sport class has 3 sub classes: B1, B2 and B3. The PT5 athletes may compete either starting together, or using the staggered start called "Interval Start System":
 - (i) In races where all sub-classes start together, the relevant compensation time will be added to the final times of the athletes competing in the sub-classes B2 and B3, as follows:

Men		Women	
Sub-class	Compensation	Sub-class	Compensation
B1	00:00:00	B1	00:00:00
B2-B3	+00:03:18	B2-B3	+00:03:48

- (ii) In races utilizing the "Interval Start System", the start list should be prepared according to the example shown in Appendix L2;
- (iii) If an athlete is reclassified into a different sub-class following observation, their finishing time will be adjusted according to the designated compensation times;
- (iv) In order to avoid overlapping or issues due to time constraints, the Race Referee may allow a mass start;
- (v) Any protests that are filed regarding the starting order and/or compensation times, shall take place according to ITU Article. 12.2., "Protest of Eligibility."

17.5. Paratriathletes' briefing:

- a.) A compulsory briefing of Paratriathletes will be held before all ITU events and will be conducted by the ITU TD. Paratriathlon coaches may also attend the briefing:
 - (i) Paratriathletes not attending the briefing without informing the TD of their absence, may be removed from the start list;
 - (ii) Paratriathletes must notify registration official(s) of their presence upon entering the briefing room.
- b.) All guides and personal handlers must be registered at the briefing;
- c.) All Paratriathletes will pick up their own race packet following the briefing. The race packet will include:
 - (i) PT1: red swim cap, 3 race number stickers for the helmet, 1 race number sticker for the handcycle, 1 race number sticker for the race wheelchair, 1 race number sticker for the daily wheelchair, 1 official race number for the athlete and 2 official race numbers for the personal handlers;
 - (ii) PT2, PT3 and PT4; red, yellow or green swim cap, 3 race number stickers for the helmet, 1 race number sticker for the bike, 3 race number stickers for the prosthesis/aiding devices, 1 official race number for the athlete or 4 sets of body marking, and 1 official race number for the personal handler;

- (iii) PT₅: 1 green swim cap for the athlete and 1 white swim cap for the guide, 6 race number stickers for the helmets, 1 race number sticker for the bike, 1 official race number **or 4 sets of body marking** for the athlete and 1 official race number for the guide with the word "GUIDE" written on it.

17.6. Paratriathlon Personal Handlers

- a.) Securing qualified personal handlers shall be the responsibility of the paratriathlete, and they should all be identified and receive credentials from the ITU technical officials at the Paratriathlon Briefing;
- b.) Personal handlers are to be allotted as follows:
 - (i) Up to one (1) personal handler for sport classes PT₂, PT₃ and PT₄. The classification process will determine for each athlete the allowance of using one handler in the competitions. The approval for already classified athletes will be done by an Approval Panel composed by:
 - ITU Head of Classification;
 - A member of the ITU Paratriathlon Committee;
 - A person designated by Sport Department.
 - (ii) Up to two (2) personal handlers for sport class PT₁;
 - (iii) No personal handlers for sport class PT₅ (Guides may act as the personal handler for this sport class).
- c.) Personal handlers are specifically allowed to assist Paratriathletes by:
 - (i) Helping with prosthetic devices or other assistive devices;
 - (ii) Lifting Paratriathletes in and out of handcycles and wheelchairs;
 - (iii) Removing wetsuits or clothing;
 - (iv) Repairing bikes and helping Paratriathletes with other equipment at the transition area or at the official wheel station. PT₅ guides can help to repair the bike along the whole bike course, without receiving external help;
 - (v) Racking the bikes in transition.
- d.) All personal handlers shall be subject to the ITU Competition Rules in addition to further regulations deemed appropriate or necessary by the Race Referee;
- e.) Any action taken by a personal handler, which propels the Paratriathletes forward may result in a disqualification;
- f.) One personal handler can assist a maximum of two athletes, provided that both athletes belong to the same sport class and gender;
- g.) All personal handlers shall be located within two (2) meters of their athletes' transition spot during the race. Permission from a Technical Official is required in order to move outside that zone.

17.7. Paratriathlon Registration Process:

- a.) Briefing registration:
 - (i) Paratriathletes have to sign the attendance list in order to enter the briefing room. At this stage, they must communicate to the registration officials whether they will have their own personal handler;
 - (ii) Paratriathletes must attend the briefing with their personal handler(s);

- (iii) Immediately after the briefing, they will collect their race package and their personal handler(s) will collect the personal handlers' t-shirt, as provided by the LOC.
- b.) Paratriathletes' lounge check in:
 - (i) Paratriathletes and personal handlers must check in together;
 - (ii) Personal handlers need to present themselves with the official race number and the official personal handler's t-shirt;
 - (iii) If a Paratriathlete is present without his/her personal handler/s, he/she has to wait until the personal handler/s arrive. If the Paratriathletes wishes to register on his/her own, then the personal handler/s will not have access to the Field of Play;
 - (iv) Once a personal handler has been registered, they can only be replaced in exceptional circumstances and only after approval by the TD;
 - (v) Timing chips will be delivered during this process; . Extra timing chip(s) should be delivered to PT1 and PT2 athletes;
 - (vi) Equipment (prosthesis, crutches, etc) for the pre-transition area (must have a race number on it) and will be checked at the Paratriathletes' lounge.

17.8. Pre-Transition area conduct:

- a.) If a pre-transition area exists, competitors in PT1, PT2, PT3 and PT4 sport classes may remove their wetsuits in this area. Only personal handlers from athletes racing in the PT1 sport class are allowed to assist their assigned Paratriathlete in this area, but cannot propel nor push the athlete forward;
- b.) All PT1 athletes must transfer in a day chair from pre-transition to transition. The wheelchairs provided by the PT1 Paratriathletes for this area must have functional brakes;
- c.) The closest available area to the swim exit area will always be used to line up the PT1 wheelchairs according to their race number;
- d.) There should be a dedicated space in the pre-transition area, to set up and display all prosthetic devices/crutches for Paratriathletes from the PT1, PT2, PT3 and PT4 sport classes (if required). A minimum of two (2) Technical Officials will coordinate the distribution of these equipment devices to the athletes as they exit the water and receive notification of the race number from the TO situated at the water exit. All of the equipment will be lined up in numerical order;
- e.) No athletes' equipment can be left in the pre-transition area, once the athlete exits the pre-transition area.

17.9. Transition Area Conduct:

- a.) No guide dogs will be allowed in the transition area at any time;
- b.) The LOC shall provide a minimum of 16 swim exit handlers at swim exit area, who will be responsible for assisting the Paratriathletes from the swim exit to the pre-transition area. The final number of swim exit handlers shall be determined by the ITU Technical Delegate. Only these persons will be allowed to enter this area. Their training should be supervised by the ITU Technical Delegate;
- c.) During the swim exit, the competitors will receive assistance from the swim exit handlers according to their swim cap colours, as follows:

- (i) Red: Paratriathlete needs to be lifted from the swim exit to the wetsuit removal area;
 - (ii) Yellow: Paratriathlete needs to be supported to walk/run from the swim exit to the wetsuit removal area;
 - (iii) Green or white: Paratriathlete does not need any assistance at the swim exit. White caps will be used for the guides.
- d.) Swim exit handlers will assist the athletes to the best of their ability, in good faith and considering safety as the main principle;
 - e.) Bicycles, tandems or handcycles are not allowed from the swim exit to the transition area;
 - f.) All equipment shall remain within each Paratriathlete's assigned space in the transition zone.
 - g.) Bike shoes must be left in the athlete assigned space in the transition area, before and after the bike segment;
 - h.) PT₅ positions in the transition area must be the closest to the mount line (women and men), followed by the rest of the sport classes PT₄, PT₃, PT₂ and PT₁. PT₁ Paratriathletes are allowed to ride the handcycle inside the transition area;
 - i.) Each PT₁ paratriathlete will have an individual space of 4x2 meters. The athlete, the handlers and all the equipment will be inside this space, during manouvres in the transition area.

17.10. Paratriathlon Swimming Conduct / Equipment:

- a.) For safety reasons, categories will be presented during the Paratriathletes' presentation at race start in the following order: PT₅, PT₄, PT₃, PT₂ and PT₁. For safety reasons, PT₁ competitors should always enter the water after all other Paratriathletes are in place;
- b.) The swim start shall be an "in-water" start;
- c.) If the swim portion consists of multiple laps, Paratriathletes will not be required to exit the water between laps;
- d.) Artificial propulsive devices including (but not limited to) fins, paddles, or floating devices of any kind are not allowed. All prosthetic and/or orthoses devices are considered propulsion devices. Use of any such devices will result in disqualification;
- e.) Any sharp objects, screws, prosthetic liners, or prosthetic devices that can be harmful are not allowed during the swim segment;
- f.) Wetsuit use is determined by the chart below:

Swim length	Wetsuits mandatory below	Maximum stay in water
750 m	18 °C	45 mins
1500 m	18 °C	1h 10 mins
3000 m	18 °C	1h 40 mins
4000 m	18 °C	2h 15 mins

- g.) If any competitor has not completed the swim course within this time limit and is more than 100 metres short of the finish, they shall be removed immediately from the water;
- h.) Wetsuits will not be permitted when the water temperature is 28 °Celsius or above;

- i.) If the water temperature is between 30.1°C and 32.0°C, the maximum distance is 750 m and the maximum stay in water 20 minutes;
- j.) The swim portion may be cancelled, if the official water temperature is higher of 32°C. or lower than 15 °C. (Official water temperature is calculated, as indicated in the chart below):
 - (i) The temperatures above are not always the water temperature used in the final decision. If the water temperature is lower than 22°C and the air temperature is lower than 16°, then the adjusted value is to decrease the measured water temperature according to the next chart:

(*)		Air temperature					
		16 °C	15 °C	14 °C	13 °C	12 °C	11 °C
Water temperature	22 °C	21.5 °C	21.0 °C	20.5 °C	20.0 °C	19.5 °C	19.0 °C
	21 °C	21.0 °C	20.5 °C	20.0 °C	19.5 °C	19.0 °C	18.5 °C
	20 °C	18.0 °C	17.5 °C	17.0 °C	16.5 °C	16.0 °C	15.5 °C
	19 °C	17.5 °C	17.0 °C	16.5 °C	16.0 °C	15.5 °C	15.0 °C
	18 °C	17.0 °C	16.5 °C	16.0 °C	15.5 °C	15.0 °C	Cancel
	17 °C	16.5 °C	16.0 °C	15.5 °C	15.0 °C	Cancel	Cancel
	16 °C	16.0 °C	15.5 °C	15.0 °C	Cancel	Cancel	Cancel

17.11.Paratriathlon Cycling Conduct / Equipment:

- a.) Paratriathlon competitions are non-drafting events. Winter Triathlon, Cross Duathlon and Cross Triathlon are draft legal events for Paratriathletes;
- b.) In paratriathlon competitions, the term “bike” used herein shall include bicycles, tandems, or handcycles;
- c.) All bikes shall be propelled by human force. Arms or legs can be used to propel the cycle, but not both. Any violation shall result in disqualification;
- d.) Bike specifications for paratriathlon competitions are outlined in the ITU Competition Rules section 5.2;
- e.) Bicycles, tandems, and handcycles must have two independent braking systems. Bicycles and tandems must have an independent brake on each wheel. **Both brakes on the handcycles will act on the front wheel;**
- f.) Disc Brakes are not allowed;
- g.) Paratriathletes with one upper limb impairment may use a splitter in the braking system and it is not considered as a bike adaptation;
- h.) Protective shields, fairings or other devices, which have the effect of reducing resistance, are not allowed;
- i.) Artificial handgrips and prosthetics are allowed but may not be fixed to the bike. Rigid prosthetic adaptations that are mounted or fixed to any part of the bike are not allowed. Any artificial handgrips or prosthetics used during the bike segment must have some method of quick-release from the handlebar;
- j.) Except for handcycles (PT1), a rider’s position shall be supported solely by the pedals, the saddle and the handlebars;
- k.) Paratriathletes with a lower limb above the knee amputation or limb defficiency not wearing a prosthesis may use a support for the thigh.

- l.) All requests for impairment adaptations to any bike or handcycle must be submitted by the corresponding National Federation in writing for ITU approval at least one (1) month before the event in which the athlete wishes to compete in, with a clear explanation and a minimum of 5 pictures using the form named "Equipment Adaptation Form" posted under:
http://www.triathlon.org/about/downloads_category/paratriathlon . The solicitant will be informed by the ITU on the outcome of the request once the panel has reviewed the information. If accepted, the information will be incorporated to the "Approved Paratriathlon Impairment Adaptations on Bicycles" file under the same location;
- m.) The ITU and the ITU technical officials shall not be liable for any consequences deriving from the choice of equipment and/or any adaptations used by Paratriathlete, nor for any defects it may have, or its non-compliance;
- n.) No guide dogs will be allowed on the bike course at any time;
- o.) No bike course shall have a maximum gradient of over 12% at the steepest section;
- p.) The use of the official race number is mandatory and must be visible from the back.

17.12.Paratriathlon PT1 Swimming Conduct/Equipment:

- a.) Athletes may only use up to 3 bindings around the legs in any position. The bindings will be 10cm in width, as a maximum;
- b.) The use of knee brace is permitted, provided the equipment provides neither flotation nor propulsion. If a wetsuit is worn, the brace shall be fitted to the outside of the wetsuit. The knee brace can cover half of the leg's surface as a maximum. The length cannot surpass the upper half of the thigh or the bottom half of the calf and has to be holding the knee/s area:
 - (i) Knee brace specifications:
 - Material: PVC plastic or carbon-fiber with no floatability or propulsion capacity;
 - It cannot have any space or chamber that traps air or any other kind of gas;
 - The thickness is limited to 5mm as a maximum.
- c.) The knee braces have to be approved by ITU. All requests must be submitted by the corresponding National Federation in writing for ITU approval at least (1) month before the event in which the athlete wishes to compete in, with a clear explanation and a minimum of 5 pictures using the form named "Knee Brace Approval Request Form" posted under:
http://www.triathlon.org/about/downloads_category/paratriathlon . The NF solicitant will be informed by the ITU on the outcome of the request once the panel has reviewed the information. If accepted, the information will be incorporated to the "Approved Knee Braces Catalog<<http://www.triathlon.org/uploads/docs/>>" file under the same location;
- d.) The use of wetsuit bottoms is always permitted.

17.13.Paratriathlon PT1 Cycling Conduct/Equipment:

- a.) Paratriathletes must use an arm powered (AP) handcycle in a recumbent position;
- b.) Specifications of a recumbent position handcycle are as follows:
 - (i) A handcycle shall be an arm powered, three-wheeled vehicle with an open frame of tubular construction, which conforms to the general principles of the International Cycling Union's (UCI) construction for bicycles (except that the

chassis frame tubes need not be straight). For the seat or backrest construction, the maximum frame tube diameter may not exceed the maximum defined by the general principles of UCI;

- (ii) The single wheel may be of a different diameter to the double wheels. The front wheel or wheels shall be steerable; the single wheel, either front or rear, shall be driven through a system comprising handgrips and a chain. The handcycle shall be propelled solely through a chainset and conventional cycle drive train, of crank arms, chainwheels, chain and gears, with handgrips replacing foot pedals. It shall be propelled by the hands, arms and upper body only;
- (iii) The Paratriathlete must have clear vision. As such, the horizontal of the Paratriathlete's eye line must be above the center of the crank housing/crank set, when (s)he is sitting with his/her hands on the handlebars facing forward at full extent, the tip of his/her shoulder blades in contact with the backrest and his/her head in contact with the headrest, when applicable. From this position, conforming measurements are calculated as follows: (#1) The distance from the ground to the centre of the Paratriathlete's eyes and (#2) the distance from the ground to the centre of the crank housing (crank set). Measurement #1) must be equal or greater than measurement #2;
- (iv) All handcycles must have a mirror fixed either to the athlete's helmet or at some point on the front of the bike to ensure rear-view vision is possible;
- (v) The athlete must have the feet positioned in front of the knees during the bike segment;
- (vi) Adjustments to handcycle may not be made during the race;
- (vii) Wheels of the handcycle may vary in diameter between a (ERTRO) 406 mm minimum and a 622 mm maximum, excluding the tire. Modified hub attachments may be used if necessary. The width of handcycle double wheels may vary between 55 cm minimum and 70 cm maximum, measured at the centre of each tyre where the tyres touch the ground;
- (viii) Disk wheels are not permitted in the front of the handcycles;
- (ix) Disk brakes are allowed on the rear wheels;
- (x) A handcycle shall not measure more than 250 cm in length or 70 cm in width;
- (xi) The shifting device can either be within the extremities of the handlebars, or on the side of the Paratriathlete's body;
- (xii) The largest chain ring shall have a guard securely fitted to protect the Paratriathlete. This protection shall be made of solid material that is sufficiently robust and covers the chain ring fully over half of its circumference (180°) on the side facing the rider;
- (xiii) Maximum frame tube diameter shall be 80 mm, irrespective of tube material, or profile. Any fillets, or ribs, inserted at joints between tubes, shall be for strengthening purposes only. Non-functional, aerodynamic devices are not permitted for competition;
- (xiv) A quick release body harness is permitted;
- (xv) It is mandatory that a handcycle with two rear wheel should be equipped with a safety bar to prevent the front wheel of a following competitor from entering the space between the rear wheels;

- (xvi) A safety bar is required and must not exceed the width of each rear wheel tyre and all tube ends must be closed or plugged. The safety bar must be fitted 15 mm (+ / - 2 mm) behind the wheels. It must be around tube (at least 18 mm in diameter) and made of adequately solid material to resist impact without bending or breaking. The distance between the ground and the bar axis must be 280 mm (+/- 10 mm). The structure and assembly of the safety bar must guarantee that normal bumps, which may be experienced during a race, don't affect the safe functioning of the bar (see diagram);

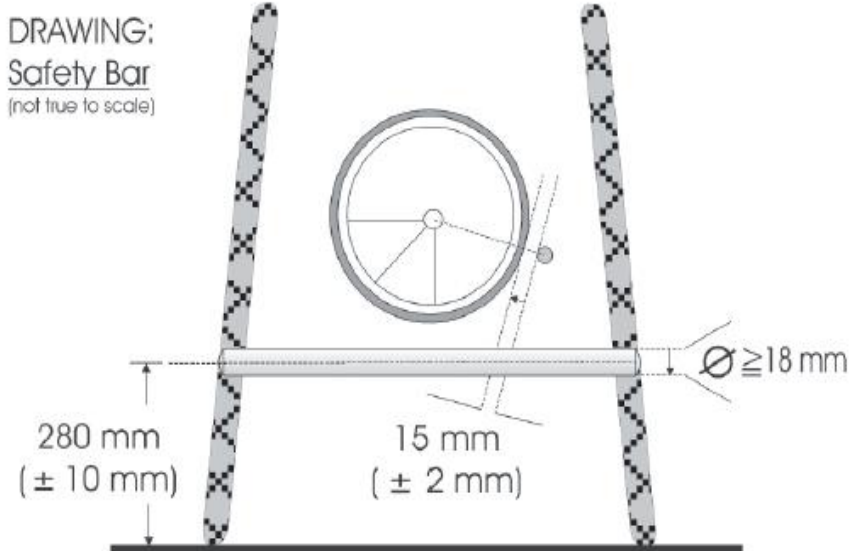

- c.) The official race number will be placed at the back of the handcycle and will be visible from the back;
- d.) The helmet must be fastened before getting onto the handcycle and it must remain fastened till the finish;
- e.) Athletes must stop completely at the mount and dismount lines. Once stopped, the athlete can continue the race.

17.14. Paratriathlon PT1 Running Conduct/ Equipment:

- a.) All competitors perform the run portion in a "racing wheelchair";
- b.) The specifications of a "racing wheelchair" (hereafter referred to as "the chair") are as follows:
- (i) The chair shall have two large wheels and one small wheel;
 - (ii) There should be a brake at the front wheel;
 - (iii) No part of the body of the chair may extend forwards beyond the hub of the front wheel and be wider than the inside of the hubs of the two rear wheels. The maximum height from the ground of the main body of the chair shall be 50 cm;
 - (iv) The maximum diameter of the large wheel, including the inflated tyre, shall not exceed 70 cm. The maximum diameter of the small wheel, including the inflated tyre, shall not exceed 50 cm;
 - (v) Only one plain, round, hand rim is allowed for each large wheel. No mechanical gears or levers that propel the chair shall be allowed;

- (vi) Only hand operated, mechanical steering devices will be allowed;
 - (vii) Competitors must be able to turn the front wheel manually to the left and right;
 - (viii) No part of the chair may protrude behind the vertical plane of the back edge of the rear tyres;
 - (ix) It will be the Paratriathlete's responsibility to ensure the wheelchair conforms to all the above rules and no event shall be delayed while adjustments are made to the chair;
 - (x) Paratriathletes must ensure no part of their lower limbs can fall to the ground during the event;
 - (xi) Paratriathletes shall wear an approved bike helmet at all times while seated in the chair.
- c.) Propulsion by any other method except the Paratriathlete pushing on the wheels or push-rims will result disqualification. A Paratriathlete attempting to overtake another Paratriathlete carries the responsibility of ensuring full clearance of the chair being overtaken before cutting across. The Paratriathlete being overtaken has the responsibility not to obstruct or impede the passing Paratriathlete once the front wheel(s) of the passing chair are in sight;
 - d.) PT₁ athletes will be judged as finished, the moment in which the centre of the axle of the leading wheel reaches the vertical plane of the nearer edge of the finish line;
 - e.) The official race number will be placed at the back of the wheelchair and visible from the back;
 - f.) No run course shall have a maximum gradient of over 5% at the steepest section;

17.15. Paratriathlon PT₂, PT₃ and PT₄ Running Conduct / Equipment:

- a.) The only acceptable footwear on the run course (besides prosthetics) are running shoes;
- b.) Athletes are permitted to use prosthesis provided that the prosthesis replaces a missing body part of the athlete. Athletes may only compete with prostheses, orthoses or other special adaptive equipment that has been checked and approved during the classification evaluation.
- c.) Athletes will wear a official race number or four sets of body decals, which will be visible from the front.

17.16. Paratriathlon PT₅ Conduct:

The following additional rules apply to all visually impaired (PT₅) competitors and their guides:

- a.) General:
 - (i) Each athlete must have a guide of the same gender and nationality. Both athlete and guide will hold a license from the same National Federation;
 - (ii) Each athlete is allowed a maximum of one (1) guide during each race;
 - (iii) An athlete must respect a waiting period of twelve (12) months after his/her last elite ITU event or any event recognized by ITU before competing as a guide;
 - (iv) All guides must comply with minimum age requirements as per the ITU Competition Rules Appendix A;

- (v) In the event of an injury or illness, and upon presentation of a medical certificate, a guide may be replaced up to 24 hours before the official start of the competition. No changes will be allowed after this deadline;
- (vi) Guides are not allowed to pull or push the athletes;
- (vii) Athlete and guide shall not be more than 1.5 meters apart during the swim segment and no more than 0.5 meters apart during any other segment of the competition;
- (viii) Guides may not use paddleboards, kayaks, etc. (on the swim portion) or bicycles, motor bicycles, etc., (on the run portion) or any other mechanical means of transport.
- (ix) All PT5 athletes from sub-class B1 must wear blackout goggles throughout the entire race, excluding the part from the swim exit to the athletes space in T1. Swim goggles may be removed once the swim is finished. Blackout glasses must be used from T1 until the athlete and guide cross the finish line. The PT5 athlete will put on the blackout glasses immediately after arriving at the assigned space inside T1 and will be used on the bike, T2 and run segments. Both the blackout goggles and glasses will be checked at registration and the athlete must ensure they do not allow light to enter through the main patched or painted area, nose piece, sides or bottom.
- (x) Athletes and guides are subject to ITU Anti-Doping Rules

b.) Swimming conduct:

- (i) Each athlete must be tethered to their own guide during the swim;
- (ii) At no time may a guide lead or pace the competitor nor propel them forward by pulling or pushing;
- (iii) The guide must swim next to the athlete within a maximum separation distance of 1.5m from the athletes' head to the guide's head. The tether will be provided by ITU, measuring around 80cm max with no tension, made out of elastic rope. The rope will have two hooks attached at each end and it is the athlete and guide's responsibility to carry their own attachable pieces, which the tether can hook on to. It can be fixed at any point of the athletes' body

c.) Cycling conduct:

- (i) All competitors and guides must use a tandem bicycle. The specifications of the tandem bicycle are as follows:
 - A tandem is a vehicle for two riders, with two wheels of equal diameter, which conforms to the general principles of UCI construction for bicycles. The front wheel shall be steerable by the front rider, known as the pilot. Both riders shall face forward in the traditional cycling position and the rear wheel shall be driven by both cyclists through a system comprising pedals and chains; the maximum sizes will be 2.70 meters long and 0.5 meters wide;
 - The tandem top tube, and any additional strengthening tubes, may slope to suit the morphological sizes of the riders.

d.) Running conduct:

- (i) Each athlete must be tethered during the run with his/her guide. They may receive verbal instructions only from their guide;
- (ii) At no time may a guide have a physical contact with the athlete. As the athlete crosses the finish line, the guide must be beside or behind the competitor but not

further apart than the required 0.5 meters maximum separation distance. They are excluded, for safety reasons the 10 metres before and after an aid station, an acute turn, penalty box, transition area swim exit, pre-transition area or any other section of the run course determined by the TD;

- (iii) The athlete may use an elbow lead during the run. In addition, the athlete may receive verbal instruction from the Guide;
- (iv) Athletes who meet the B1 sub-class criteria will need to wear black out glasses through the run.

17.17. Hygiene:

- a.) It is mandatory for all paratriathlon competitors, who use catheters or other urinary diversion devices, to prevent spillage by using a catheter bag at all times. This includes during training, competition and classification.

17.18. Approval panels:

- a.) Decisions on bike adaptations or brace approval will be made by a panel composed of:
 - (i) An ITU Technical Committee member;
 - (ii) A representative of the ITU Sport Department;
 - (iii) A member of the ITU Paratriathlon Committee;
 - (iv) A representative of the ITU Athletes' Committee;
 - (v) A representative of the ITU Coaches' Committee.
- b.) The decisions of the Approval Panel can be appealed to the ITU Arbitration Tribunal. This appeal does not suspend the decision of the Approval Panel, but rather the decision will stay in place during the time the ITU Arbitration Tribunal takes to make a decision on the appeal.

18. WINTER TRIATHLON:

18.1. Definition:

- a.) Winter Triathlon may take place in two different formats:
 - (i) Running, mountain biking and cross country skiing, named as Winter Triathlon;
 - (ii) Snowshoeing, skating and cross country skiing, named S₃ Winter Triathlon.
- b.) All segments of the race will be preferably on snow or ice. The run and bike segment can also take place on a different surface.

18.2. Official Training and course familiarisation:

- a.) Official training and familiarisation sessions will be conducted by the Technical Delegate and the LOC. Athletes and coaches may attend these official training and familiarisation sessions;
- b.) Conduct on race days: Athletes are not allowed to warm up or do any familiarisation on the course while a race is in progress.

18.3. Run Segment:

- a.) Running shoes are mandatory on the running segment. This rule is not applicable to Age Group athletes;
- b.) Running shoes with spikes are allowed.

18.4. Mountain Bike Segment:

- a.) The minimum tyre dimension is 26x1.5 inches which means the smallest part of the tyre should not be less than 40mm;
- b.) The bike segment of winter triathlon competitions is laid out as a cross-country course over snow and may follow normal roads or paths;
- c.) Athletes are allowed to push or carry the bike over the course;
- d.) Drafting is allowed; for safety reasons it may be forbidden to pass other athletes before entering the transition area. Lapped athletes will not be removed from the race;
- e.) Athletes must bring their own tools and parts and must carry out their own repairs;
- f.) Bike shoes are mandatory in the bike segment. This rule is not applicable to Age Group athletes;
- g.) Spiked tyres are allowed provided that the spikes are shorter than 5 mm. measured from the tyre surface.

18.5. Ski Segment:

- a.) Testing of equipment (skis) is allowed prior to the race on specially marked tracks, or on the race-course, if announced by the Technical Officials;
- b.) Athletes cannot be accompanied by team members, team managers or other pacemakers on the course, during the race;
- c.) Athletes are allowed to change one ski and both poles;
- d.) Athletes may ski using their preferred technique;
- e.) Specified zones may have restrictions to classic style or double poling;
- f.) Wearing the bike helmet during the ski segment is not allowed. However, due to the effect of cold temperatures on mobility, wearing a helmet could be authorised by the TD;

- g.) Once a request to pass is made by a athlete, the athlete being passed must move to the side as soon as possible;
- h.) In the finish chute (30-50m), freestyle skiing may be forbidden. Double poling may be mandatory and prepared tracks for classic technique must be used. This provision will be announced at the athletes' briefing;
- i.) Athletes cannot remove their skis until at least 10 metres past the finish line. The last ski check will take place after this line;
- j.) Ski shoes are mandatory in the cross country ski segment. This rule is not applicable to Age Group athletes.

18.6. Snowshoeing segment:

- a.) The entire course must be completed with the snowshoes on the participant's feet;
- b.) Athletes are not allowed to change any of the snowshoes;
- c.) The snowshoes must measure a minimum of 18 cm (7 inches) wide by 51 cm (20 inches) long and they must have a minimum useable surface of 774 cm² (120 square inches);
- d.) Once a request to pass is made by a athlete, the athlete being passed must move to the side as soon as possible.

18.7. Skating Segment:

- a.) All types of skates, including Nordic blades, are allowed;
- b.) Athletes are not allowed to change any of the skates;
- c.) Once a request to pass is made by a athlete, the athlete being passed must move to the side as soon as possible;
- d.) Athletes will wear helmet, as outlined in Competition Rules 5.2 e).

18.8 . Transition Area Conduct:

- a.) Skiing inside the transition area is forbidden;
- b.) Competitors must put on and take off their snowshoes and skates within the transition area, in the athletes' own space. If a "Nordic blades changing zone" is provided, athletes may choose to put the Nordic blades on there;
- c.) In the transition area, Technical Officials may assist athletes by receiving and placing their bikes and handing out their equipment. This service must be equal for all athletes;
- d.) All athletes must have their helmet securely fastened from the time they remove their bike from the rack at the start of the bike leg or when they put the skates on, until after they have placed their bike on the rack at the finish of the bike leg or when they take the skates off;
- e.) A "Nordic blades changing area" may be created by the side of the edge of the ice;
- f.) A littering zone will be placed after the "ski placing line" where the athletes can discard the shoe covers.

18.9 . Coaches' Zone:

- a.) Coaches will have a designated space available on the bike segment in order to supply athletes with their own food and beverages.

18.10. Finish Definition:

- a.) An athlete will be judged as “finished,” the moment the tip of the front ski boot crosses a vertical line extending from the leading edge of the finish line.

18.11. Weather conditions:

- a.) The race will be cancelled when the air temperature is lower than -18°C .

19. CROSS TRIATHLON AND DUATHLON:

19.1. General:

- a.) Cross Triathlon consists of swimming, mountain biking (MTB) and cross-country running;
- b.) Cross Duathlon consists of cross-country running, mountain biking (MTB) and cross-country running.

19.2. Distances:

- a.) The distance of Cross Triathlon is outlined in Appendix A;
- b.) The distance of Cross Duathlon is outlined in Appendix A;
- c.) The course should have demanding hills and challenging technical aspects. A 5% tolerance margin will be accepted for the distance of the bike course, provided it has been approved by the Technical Delegate.

19.3. Official Training and Familiarisation:

- a.) Official training and familiarisation sessions will be conducted by the Technical Delegate and the LOC. Athletes and coaches may attend these official training and familiarisation sessions;
- b.) Conduct on race days: Athletes are not allowed to warm up or do any course familiarisation while a race is in progress.

19.4. Mountain Biking Conduct:

- a.) The maximum tyre diameter for the MTB is 29 inches. The minimum cross section is 1.5 inch;
- b.) Studded and/or slick tyres are allowed;
- c.) Athletes are allowed to push or carry the bike over the course;
- d.) Lapped athletes will not be removed from the race;
- e.) Clip-ons are not allowed;
- f.) Traditional road handlebars are forbidden;
- g.) Traditional MTB bar ends are authorised.

19.5. Running Conduct:

- a.) Spike shoes are allowed.

19.6. Coaches Stations:

- a.) Coaches will have a designated space available on the bike and run segments in order to supply athletes with their own food and beverages.

20. COMPETITION IN QUALIFYING ROUND FORMAT:

20.1. General:

- a.) A competition in Qualifying Round Format consists of several rounds with a number of heats each qualifying athletes to the next round and eventually finishing with a final to determine a winner.

20.2. Rounds:

- a.) The rounds will be called semifinals and final;
- b.) A competition will have two rounds;
- c.) Semifinals and final will have 30 athletes as a maximum. The number of semifinals will be as follows:

Athletes entered	Semifinals
Less than 30	No semifinals, direct final
31 to 60	2 semifinals (15 to 30 athletes each)
61 to 90	3 semifinals (20 to 30 athletes each)
91 to 120	4 semifinals (22 to 30 athletes each)
121 to 150	5 semifinals (24 to 30 athletes each)

20.3. Qualification to final:

- a.) Every semifinal will qualify a fixed number of athletes for the final. Additionally, a number of athletes will qualify from semifinal heats, based on fastest times:

Athletes entered	Semifinals	By position in the semifinal	By time
31 to 60	2	14	2
61 to 90	3	9	3
91 to 120	4	7	2
More than 121	5	5	5

- b.) Athletes from different heats and with the same time (in seconds), which are tied in the last qualifying position, will all qualify, increasing the number of athletes qualified for the next round;
- c.) Athletes who have not qualified for the final will be sorted by time. In case of athletes withdrawing from the final, replacement will be made by the first athlete who has not qualified. The replacement will happen if the number of athletes in the final drops down to 30 athletes. (a random selection will be made from those athletes who have the same time). The deadline for the replacements will be when registration opens.
- d.) In case where a race has a B final, the best 30 athletes from the semi-finals who have not qualified for the A final, will be sorted according to their times and will qualify to race in the B final.

20.4. Distribution of athletes in the semifinals:

- a.) The TD will compose the heats as follows:
 - (i) If there are not any applicable rankings, the athletes will be distributed among the heats in order to have the same number of athletes per semifinal (some semifinals can have one more athlete than others). The athletes from the same NF will be distributed among the heats following the same principle;

- (ii) If a ranking is applicable, the ranked athletes will be distributed according to the chart below and the non-ranked athletes will fill the remaining spots by applying the principle of assigning a similar number of athletes from the same NF to every heat, and keeping all the heats of equal size.

Chart. Distribution of ranked athletes among the semifinals:

Semifinal 1	Semifinal 2	Last Semifinal (-1)	Last semifinal
1			
	2		
		3	
			4
			5
		6	
	7		
8			
9			
	10		
		11	
			12
			13
		14	
	15		
16			
17			
etc...			

Note: The number reflects the ranking order

20.5. Numbering:

- a.) The numbers in the final will be assigned as first criteria according to the positions in the semifinals. The second criteria will be the time in the semifinal, the third, the ITU Points List position, and the fourth a random apportionment.

20.6. Results:

- a.) The overall results for the event will be the results of the final round;
- b.) If the event is included in any ranking which is allocating points to more positions than finishers in the final, the remaining points will be awarded as follows:
- (i) To the DNF athletes in the final, according to their times in the semifinals;
 - (ii) To the DNS athletes in the final according to their times in the semifinal;
 - (iii) If the race does not have a B final: The athletes who did not qualify for the final, will have points allocated according to their times in the semi-finals. If the race has B final: The results from the B final will determine their points.
 - (iv) DSQ athletes will not earn any points.

20.7. Prize money:

- a.) Prize money distribution will follow the general rules (Appendix I) and the preceding paragraph if necessary.

21. AQUABIKE:

21.1. General

- a.) Aquabike consists of Swimming, T₁, biking and T₂.
- b.) Aquabike events will be organised only under Long Distance and for Age Group categories, and included in the program of a Long Distance Triathlon event.

21.2. Distance

- a.) From 1900 meter swim and longer followed by 80 km bike or longer, mirroring the distance of the Long Distance Triathlon event in which the aquabike is included.

21.3. Specific Rules

- a.) Aquabike is ruled by the same rules that the Long Distance Triathlon event in which is included.

21.4. Finish

- a.) Athletes will finish the race at the finish line located by the T₂ exit. The time registered in this point is the final time.



APPENDICES

22. APPENDIX A: RACE DISTANCES AND AGE REQUIREMENTS:

Triathlon:

	Swim	Bike	Run	Minimum age required
Team relay	250 to 300 m	5 to 8 km	1,5 to 2,0 km	15
Super Sprint Distance	250 to 500 m	6,5 to 13 km	1,7 to 3,5 km	15
Sprint Distance	Up to 750 m	Up to 20 km	Up to 5 km	16
Standard Distance	1500 m	40 km	10 km	18
Middle Distance	1900 to 3000 m	80 to 90 km	20 to 21 km	18
Long Distance	1000 to 4000 m	100 to 200 km	10 to 42,2 km	18

Duathlon:

	Run	Bike	Run	Minimum age required
Team Relay	2 km	8 km	1 km	15
Sprint Distance	5 km	20 km	2,5 km	16
Standard Distance	10 km	40 km	5 km	18
Long Distance	20 km	80 km	10 km	18

Aquathlon:

	Run	Swim	Run	Minimum age required
Standard Distance	2,5 km	1000 m	2,5 km	16
Standard Distance (cold waters)		1000 m	5 km	16
Long Distance	5 km	2000 m	5 km	18
Long Distance (cold waters)		2000 m	10 km	18

Winter Triathlon:

Winter Triathlon	Cross-Country Run	Mountain Bike	Cross-Country Ski	Minimum age required
Team Relay	2 to 3 km	4 to 5 km	3 to 4 km	15
Sprint Distance	3 to 4 km	5 to 6 km	5 to 6 km	16
Standard Distance	7 to 9 km	12 to 14 km	10 to 12 km	18

S3 Winter Triathlon	Snowshoeing	Skating	Cross-Country Ski	Minimum age required
Standard Distance	4 to 6 km	10 to 14 km	7 to 9 km	16

Cross Triathlon:

	Swim	Mountain Bike	Cross Country Run	Minimum age required
Team Relay	200 m	4 to 5 km	1,2 to 1,6 km	15
Sprint Distance	500 m	10 to 12 km	3 to 4 km	16
Standard Distance	1000 to 1500 m	20 to 30 km	6 to 10 km	18

Cross Duathlon:

	Cross Country Run	Mountain Bike	Cross Country Run	Minimum age required
Team Relay	1,2 to 1.6 km	4 to 5 km	0,6 to 0,8 km	15
Sprint Distance	3 to 4 km	10 to 12 km	1,5 to 2 km	16
Standard Distance	6 to 8 km	20 to 25 km	3 to 4 km	18

23. APPENDIX B: RACE PROTEST FORM:



INTERNATIONAL TRIATHLON UNION

PROTEST FORM

Part 1: To be completed by the protester.

Protest must be filed and signed by the protester under the conditions outlined in the ITU Competition Rules and submitted to the Race Referee.

Event Name:		Event Date:	
Event Location:		Time Protest Submitted:	
Name of Protester:		Race Number:	
Country of Protester:		Email:	
Address of Protester			
	(street address)	(City and Postal Code)	
Telephone (home):		Telephone (mobile):	
Name of Protestee:		Race Number:	
Country of Protestee:			

A protest is a formal complaint against the conduct of a fellow athlete or race official, or against conditions of the Competition. You must have substantial evidence, including witnesses, and you must be willing to take part in an interview. Any protest must be accompanied with a cheque or cash for \$50 USD or equivalent amount.

What type of Protest is involved? (Check one box only.)

- Protest Concerning the Course
- Protest Against Another Athlete or a Technical Official
- Protest Concerning Eligibility
- Protest Concerning Timekeeping
- Protest Concerning Equipment

Witness Details (2):

Name of Witness 1:

Name of Witness 2:

Rule(s) Violated:		Time of Incident:	
-------------------	--	-------------------	--



Where did the Violation occur. (Define location. If required use additional paper and draw a diagram.)	
Who was involved in the Violation?	
How did the Violation occur (brief statement explaining alleged violation)?	
Signature of Protester:	Date:

Part 2 Official use only

Protest Fee \$50 USD attached		Yes <input type="checkbox"/>	No <input type="checkbox"/>
Competition Jury Members (Names) and tick box to indicate if it was a 3 person jury or 5 person. <input type="checkbox"/> 3 person jury <input type="checkbox"/> 5 person jury	1.		
	2.		
	3.		
	4.		
	5.		
Competition Jury Action:			
Competition Jury Chair's Name			
Signature:			
Time, Date Protes received:			
Time, Date Protest processed:			
Amount of fee withheld/refunded:			

24. APPENDIX C: RACE APPEAL FORM:



INTERNATIONAL TRIATHLON UNION

APPEAL FORM

Part 1: To be completed by the appellant:

Appeals must be filed and signed by the appellant under the conditions outlined in the ITU Competition Rules, and submitted to the Technical Delegate. An appeal is a request for a review of a decision made by the Race Referee. This is the first level of appeal and will be heard by the Competition Jury. All appeals must be accompanied with a cheque or cash for \$50 USD or equivalent amount.

Event Name:			Event Date:	
Event Location:			Time Appeal Submitted:	
Name of Appellant:			Race Number:	
Country of Appellant:			Email:	
Address of Appellant:				
	(street address)		(City and Postal Code)	
Telephone (home):		Telephone (mobile):		
Reason for penalty received:			Type of penalty received (DQ, Suspension):	
Was the penalty confirmed by the Race Referee?	Yes <input type="checkbox"/> No <input type="checkbox"/>			

Type of Appeal: (Check one box only.)

- Appeal against the Race Referee’s ruling on a Violation Report
- Appeal against the Race Referee’s ruling on a Protest:

Specific Location on the Course: _____

Name and Number of Race Official(s) / Athlete(s)/ Spectator(s) if Known _____

Description of the Incident (Use additional paper if required) _____



Witness Details (2):

Name of Witness 1: _____

Name of Witness 2: _____

Date: _____

Signature of Appellant: _____

Part 2 Official use only

Appeal Fee \$50 USD attached	Yes <input type="checkbox"/> No <input type="checkbox"/>
Is this Appeal to reverse a Competition Jury decision?	Yes <input type="checkbox"/> No <input type="checkbox"/>
If 'Yes', attach Competition Jury Decision and action(s) and Race Referee's decision and action(s).	
Competition Jury Members (Names) and tick box to indicate if it was a 3 person jury or 5 person. <input type="checkbox"/> 3 person jury <input type="checkbox"/> 5 person jury	1.
	2.
	3.
	4.
	5.
Competition Jury Action:	
Competition Jury Chair's Name	
Signature:	
Time, Date Appeal Received:	
Time, Date Appeal processed:	
Amount of fee withheld/refunded:	

25. APPENDIX D: DEFINITIONS:

Age	The age of the athlete on the 31st of December of the year of the competition.
Age group Team Managers Briefing	Meeting with the Age group team manager and coaches in which they are informed by the TD about all the specifications of the race.
Aid/Outside Assistance	Any kind of material support or personal assistance received by the athlete. Depending on its nature, it may be allowed or forbidden
Ambush Marketing	Deliberately using the opportunity of live television and media photographers to expose the sponsor logos larger than the approved sizes, and/or equipment or objects not provided by LOC or ITU.
Appeal	A request to the Competition Jury of an event or the ITU Arbitration Tribunal for a review of the decision of the Race Referee/Competition Jury. (Note: This cannot include an appeal against the finding of a doping violation or against the penalty imposed for the finding of a doping violation. These appeals must be directed to ITU Arbitration Tribunal independently.)
Appellant	An athlete submitting an appeal.
Aquabike	Multisport which combines swim and cycle in two segments: the first segment is swimming and finishing with cycling.
Aquathlon	Multisport which combines swim and run in three segments: the first segment is run, followed by swimming and finishing with running.
Assistance	Any attempt by an unauthorised or unofficial source to help or to stabilise an athlete.
Assistant Chief Technical Official	Responsible to the Chief Technical Official for coordinating the employment of the Technical Officials assigned to his/her race course segment or area.
Athletes	The competitors who register for and compete in ITU events.
Athletes' Briefing	Meeting with the athletes in which they are informed by the TD about all the specifications of the race.
Bicycle	The bicycle is a human powered vehicle with two wheels of equal diameter. The front wheel shall be steerable; the rear wheel shall be driven through a system comprising pedals and a chain. Bicycles are also referred as bikes.
Blocking	The deliberate impeding or obstructing of progress of one athlete by another. An athlete on the bike course, who is not keeping to the appropriate side of the road.
Blue card	Card, which is used to inform athletes when being penalised for drafting infringement during cycling segment.
Charge	The contacting of one athlete by another from the front, rear or side, and hindering that athlete's progress.
Check in	Control established at the entrance of the athletes lounge and at the entrance of the transition area, before the race. In both places a time of admission is set by TD.

Chief Technical Official	Appointed by the Technical Delegate and is responsible for the control and co-ordination of the deployment of Technical Officials.
Clean Start	All the athletes start after the horn. The race continues.
Coaches meeting	Meeting with the coaches in which they are informed by the TD about all the specifications of the race.
Competition Jury	The Competition Jury appointed and chaired by the Technical Delegate. It is held responsible to determine the eligibility of the protest or appeal, to hear and to rule on all appeals against decisions handed down through the Race Referee, including decisions on protests.
Conflict of interest	A set of circumstances that creates a risk that professional judgement or actions regarding a primary interest will be unduly influenced by a secondary interest
Continent	Each of the five geographical divisions established in ITU. They are: Africa, The Americas, Asia, Europe and Oceania
Continental Technical Officials (CTOs)	The Level 2 Technical Officials certified by ITU.
Course	A forward line of progress from start to finish, which must be clearly marked and measured to prescribed specifications.
Crawling	The action by an athlete of bringing three or more limbs in contact with the ground, either together or in any sequence, to enable forward propulsion.
Cycling Segment	Part of the race course over which it has been defined in the Athletes' Briefing the bike is to be ridden, walked or carried within distinctive lane boundaries. The bike course commences from the Mount Line and concludes at the Dismount Line.
Dismount Before The Dismount Line	An athlete's foot must contact the ground entirely before the dismount line. If this contact doesn't occur, it is considered an infringement of the rules.
Dismount Line	A designated line at the entrance of the transition area from the bike course before which athletes are to dismount their bikes fully and proceed to the bike racks. The Dismount Line will normally extend for the width of the entrance to the transition area and be identified by flags/line/Technical Official, or combinations thereof.
Disqualification	A penalty assigned as appropriate for the rule violation, which has been reported, or for which a protest has been upheld. As a result of this penalty, the athlete will not be given finish or split times for the event, no account will be taken of the athlete when placings are assessed for any category or for the race as a whole, and the athlete's results will appear as DSQ.
Draft Zone Bicycle	Zone defined by an athlete during the cycling segment which is extended to the whole width of the road and 10 meters long in the standard and shorter events and 12 meters long in middle and long distance events.
Draft Zone Motorbike	Zone defined by a motorbike during the cycling segment which is extended to the whole width of the road and 12 meters long.
Draft Zone Vehicle	Zone defined by a vehicle during the cycling segment which is extended to the whole width of the road and 35 meters long.

Drafting	To enter in a drafting zone and not completing the overtake in 20 seconds in standard and shorter events or 25 seconds in middle and long distance events.
Duathlon	Multisport which combines cycle and run in three segments: the first segment is running, followed by cycling and finishing with running.
Early start	When an athlete's foot crossed the vertical plane of the start line, before the start signal.
Elite	Elite athletes are those competing in elite races.
Event Organisers Manual (EOM)	A document which has been developed to ensure the implementation of consistently high global event management and marketing standards.
Expulsion	An athlete penalised by expulsion will not be permitted, during his or her lifetime, to take part in any ITU sanctioned event, or any event sanctioned by one of its member associations (National Federation) affiliated with the ITU.
Field of Play (FOP)	The course on which the competition portions of the ITU event will take place.
Final	Last round of an event in qualifying round format. The final decides the winner and the medallist of the event.
Finisher	An athlete who completes the entire race course within the rules and crosses the finish line, or a vertical extension of the forward edge of the finish line, with any part of the torso (i.e. as distinct from the head, neck, arms, legs, hands or feet).
Force Majeure	Action of the elements, strike, lockout or other industrial disturbance, unlawful act against public order or authority, war blockade, public riot, lightning, fire or explosion, storm, flood, blacklisting, boycott or sanctions however incurred, freight embargo, transportation delay or any other, event which is not reasonably within the control of the party affected.
Incapable Athlete	An athlete deemed by race medical staff as not being able to continue the event without the likelihood of causing injury to him/herself or another athlete.
Indecent Exposure	The willful uncovering of either or both buttocks, or of the pubic area or of the genital area. In addition, in the case of a female athlete, the willful complete uncovering of one or both nipples.
Interference	A deliberate block, charge or abrupt motion, which impedes another athlete.
International Technical Officials (ITOs)	The Level 3 Technical Officials certified by ITU.
International Triathlon Union (ITU)	The world governing body of triathlon, duathlon, aquathlon, winter triathlon and all other related multisport, a non-profit corporation domiciled and residing at Maison du Sport International, Av de Rhodanie 54, CH-1007 Lausanne, Switzerland.
ITU Competition Rules	The document that contains all the rules and regulations that governs fair and safe competitions.

ITU Members	The National Federations and Continental Confederations affiliated to ITU.
ITU Rules	The ITU Event Organisers' Manual (latest edition), ITU Competition Rules, ITU Constitution and By-Laws, ITU Uniform Rules, ITU Anti-Doping Rules and WADA Code, ITU Athletes' Agreement, ITU Qualification Criteria, ITU Ranking Criteria and any other rules adopted and amended by ITU from time to time and available for consultation via the download section of the ITU's official website www.triathlon.org .
Invalid Start	Some athletes start clearly before the horn and some others stay behind the start line. The start is not clean and is declared invalid.
Local Organising Committee (LOC)	The organising entity of an ITU event.
Mount After The Mount Line	An athlete's foot must contact the ground entirely past the mount line. If this contact doesn't occur, it is considered an infringement of the rules.
Mount Line	A designated line at the exit from the transition area onto the bike course or after which athletes are to mount their bicycles and proceed. The Mount Line will normally extend for the width of the exit of the transition area and be identified by flags/line/Technical Official, or combinations thereof.
National Federation (NF)	National triathlon governing body affiliated with ITU.
National Technical Officials (NTOs)	The Level 1 Technical Officials certified by the NF.
Overtake	On the bike course, when the leading edge of the front wheel of the overtaking bike moves in front of the leading edge of the front wheel of the bike being overtaken. An athlete can pass another athlete only on the appropriate side.
Pack	Two or more athletes with overlapping draft zones.
Pass	When one athlete's bike draft zone overlaps another athlete's bike draft zone, makes continual forward progress through that zone and overtakes within a maximum period of 20 seconds. An athlete can pass another athlete only on the appropriate side.
Penalty	The consequence on an athlete, who is assessed by an ITU Technical Official to have unintentionally committed a rule infringement/violation. A penalty may take the form of a time delay, disqualification, suspension or expulsion.
Penalty Box	An area on the bike course or the run course, set aside for the implementation of a time penalty for a rule infringement/violation.
Prosthesis	An artificial device used to replace a missing body part.
Protest	A formal complaint against the conduct of another athlete or a race official, or against the conditions of the competition.
Race Referee	A Technical Official, who is responsible to the Technical Delegate to hear and make final decisions on all rules violations reported by Technical Officials. Technical Delegate appoints the Race Referee
Red card	Card, which is used to inform athletes about disqualification.

Region	Group of National Federations, from the same or different continents, linked by geographical or cultural reasons.
Registration	Point of control established at the entrance of athletes briefing and coaches meeting. Attenders to these meetings will sign the attendance list.
Results	The timed finish positions of all athletes after violation reports have been ruled on, protests and appeals have been heard, and penalties have been awarded.
Right of Way	When an athlete has established a lead position and pursues a desired course within the limits of the ITU Competition Rules.
Round	Each of the stages of an event with qualifying format. One event in qualifying round format has two rounds: semifinals and final.
Run Course	Part of the race course, which has been defined at the Athletes' Briefing where the athlete is to run or walk within distinctive lane boundaries. In triathlons and aquathlons, the run course commences at the exit from the transition area and concludes at the Finish Line. In duathlons, the first run course commences at the start line and finishes at the entry to the transition area; the second run course commences at the exit from the transition area and concludes at the Finish Line.
Sanction	A permit issued by the National Federation for the conduct of an event. The issue of such a permit is a declaration by the sanctioning authority that plans for the event have been thoroughly inspected and have been found to comply fully with the requirements of National Federation operating requirements to provide the greatest potential for the conduct of a safe and fair event.
Semifinal	Preliminary round of an event in qualifying round format. The semifinals determine the athletes qualified to the final.
Sport Class	Paratriathlon sport class is a category defined by ITU in which athletes are categorised in reference to an activity limitation resulting from impairment.
Sportsmanship	The behavior of an athlete during competition. Sportsmanship is interpreted as fair, rational and courteous behavior, while bad sports conduct is any behavior judged to be unfair, unethical or dishonest, a violent act, intentional misconduct, abusive language, intimidating behavior, or persistent infringement of the rules.
Standard Bridge Piece	A rigid piece, of plastic or metal, which joins both sides of the handlebar clip-on at the ends and is commercially available.
Stop and Go	Penalty consisting on stop, correct the fault and continue the race.
Sub-class	Division made inside a paratriathlon sport class. Each paratriathlon sub class includes Paratriathletes from the same sport class and having similar impairment conditions.
Suspension	An athlete awarded this penalty will not be permitted during the stated suspension period, to take part in any event sanctioned by ITU or its member associations (where determined) affiliated with ITU. For any suspension because of a doping violation, the athlete will not be able to compete in any IOC affiliated sport at any local, regional, state, national or international level. The suspension period may vary in length, depending on the severity of the violation. In the case of a suspension

	imposed by ITU, the length of the suspension will be determined by the ITU Arbitration Tribunal .
Swim Course	Part of the race course over which it has been defined in the Athletes' Briefing that the athlete is to swim within distinctive lane boundaries. In triathlons and aquathlons, the swim course commences at the start line and concludes at the water's edge/exit prior to entry to the transition area.
Technical Delegate	A Technical Official, who is qualified by ITU, and responsible for ensuring all aspects of the ITU Competition Rules and ITU Event Organisers' Manual are fulfilled in preparation for, during, and after the event. Where appeals are lodged, the Technical Delegate will be the Chair of the Competition Jury. The Technical Delegate will normally be responsible for conducting or overseeing the conduct of event sanctioning.
Technical Official	A member of the joint team of International Technical Officials (ITOs), Continental Technical Officials (CTOs) and National Technical Officials (NTOs) at an ITU event.
Time Penalty	Penalty consisting on stop at the penalty box for a certain time. Early start time penalty is served in T1 instead the at the penalty box.
Torso	The human body excluding the neck, the head and the limbs.
Transition Area	A location within a defined boundary, which is not a part of the swim course, the bike course or the run course and within which each athlete is allocated an area for the storage of individual items of clothing and equipment.
Triathlon	A sport of individual or team character and motivation, which combines swimming, cycling and running skills in continuum.
Valid Start with Early Starters	Start in which few athletes started before the signal. Early starters will receive a time penalty in T1
Venue	All warm-up and competition areas, the air space above such areas, official hotel, broadcasters, press and media areas, sport expo area, contiguous areas, including without limitation spectators' area, VIP areas, transition area, finish area and all other areas under control of LOC.
Violation	A rule infringement which results in a penalty.
Warning	A caution issued by a Technical Official to an athlete during the course of a race. The purpose of a warning is to alert the athlete of the potential for a rule violation to occur and to promote a pro-active attitude.
Winter Triathlon	Multisport which combines different winter sports. It may have two different formats, either starting with running on snow, followed by cycling on snow and finishing with cross country skiing, or starting with snow shoeing followed by skating on ice and finishing with cross country skiing.
Yellow card	Card, which is used to inform athletes about infringements which may result in warning, time penalty or stop and go.

26. APENDICES E: QUALIFICATION AND RANKING CRITERIA

APPENDIX E1. ITU World Triathlon Series

QUALIFICATION CRITERIA

1. ELITE:

1.1. ITU World Triathlon Series events:

- a.) The National Federations must enter the athletes into the wait list via the ITU online entry system no fewer than 33 days before the first competition day;
- b.) 32 days before the first competition day, the start list for both the men's and women's will be published on www.triathlon.org adding up to 60 athletes from the waitlist in the following order:
 - (i) The athletes with the most points from the current ITU Points List;
 - (ii) The rest of the athletes sorted according to the NF alphabetical order starting by the host NF;
 - (iii) The athletes exceeding 60 will remain on the wait list, in the same order indicated in (i) and (ii) above;
- c.) National Federation quota in each of the men's and women's event:
 - (i) Maximum per National Federation is 6 athletes;
 - (ii) Maximum per host National Federation is 8 athletes;
 - (iii) Maximum per National Federation and host National Federation may be increased by a maximum of 4 quota places if at any moment of the process the number of athletes on the start list is lower than 60.
- d.) Late Entries: Entries received 32 or fewer days before the first competition day will be placed at the bottom of the wait list at the time the National Federation entered the athlete into the ITU online entry system;
- e.) Invitations: 26 days before the first competition day, the ITU invitation panel will award a maximum of 5 invitations based on the requests, but not limited to, emailed by respective National Federations to entries@triathlon.org and they will be put on the start list. If the ITU invitation panel awards less than 5 invitations, the remaining spot will be filled by the next athlete on the wait list:
 - (i) The ITU Invitation Panel is composed by:
 - The ITU Secretary General;
 - A representative of the ITU Sport Department;
 - A representative of ITU Development.
- f.) Substitutions: Each National Federation will be allowed to substitute 1 athlete per gender per event. The names of both athletes involved in the substitution must be emailed to entries@triathlon.org. Substitutions are only allowed up to 12 days prior to the first competition day;
- g.) Athletes exceeding the maximum National Federation quota will be admitted in the start list only if no other athletes remain in the waiting list. The acceptance of athletes exceeding the NF quota will follow the order of one athlete per NF, according to their positions in the waiting list. Once all affected NFs will have one more athlete than the

maximum NF quota in the start list, the second exceeding athletes will be moved to the start list, etc.

- h.) Withdrawals: An athlete who is withdrawn from the start list will be replaced by the next athlete on the wait list. According to the rule 2.6.c) (iii) Athletes not attending the briefing, without informing the TD about their absence, will be removed from the start list. In this case, athletes from the wait list who attended the briefing will be called to fill the empty slots. Athletes present in the race briefing and still remaining on the wait list must stay nearby and in close contact in order to take the place of any upcoming withdrawals, until registration closes;
- i.) If a National Federation withdraws an athlete from the start list within 25 days of competition they must email entries@triathlon.org. If there is a second withdrawal within 25 days of the first day of competition by the same National Federation, the country will lose 1 quota spot for the following 2 ITU World Triathlon Series events and the maximum quota of the National Federations affected will be adjusted accordingly for those events. This penalty will be applied from the day of the race briefing and to the 2 next WTS events which has not the start list created. This penalty will carry over to the following year if occurs near to the end of the season;
- j.) National Federations withdrawing an athlete from the start list after the Monday at 13:00 UTC prior to the first event, the athlete will be removed from all start lists and wait lists of any ITU events for the next 30 days and will not be reinstated in any of the races on the same weekend as the race from which they were withdrawn.
- k.) A number of unexpected withdrawals without being penalised because last minute issues are fixed. This benefit extends for both athletes and NFs penalties. The number depends on the number of participations of each NF over the previous year, as follows:

Number of late withdrawals not penalised (*)	National Federations
6	AUS, GBR, GER, JPN, RUS, USA
5	ESP, NZL
3	CAN, FRA, POR, RSA, SUI
2	All the others

(*) This includes men and women events in all WTS events, the Grand Final and World Cup events.

- l.) An athlete not personally present at the Athletes' Briefing and who has not provided prior notification to the Technical Delegate by email or by phone will be removed from all start lists and wait lists of any ITU events for the next 30 days and will not be reinstated in any of the races on the same weekend as the race from which they were withdrawn;
- m.) Athletes present at the Athletes' Briefing but are forced to withdraw from the competition due to last minute illness or injury, as proven by a certificate from a medical doctor, will remain on future start lists and wait lists of all ITU events;

1.2. ITU World Triathlon Series Grand Final:

- a.) The National Federations must enter the athletes into the wait list via the ITU online entry system no fewer than 26 days before the first competition day;
- b.) 25 days before the first competition day, the start list for both the men's and women's will be published on www.triathlon.org adding athletes from the waitlist in the following order:
 - (i) 50 athletes with the most points from the current ITU Points List;

- (ii) The top 3 finishers of the last ITU Triathlon Continental Championships in elite category from all 5 continents. If the athlete is qualified by the first 3 ballots above, the spots will be allocated according to the ITU Points List;
 - (iii) The remaining athletes will be sorted according to the ITU Points list and those without points according to the NF alphabetical order starting by the host NF;
 - (iv) The athletes listed at positions 66 and above will remain in the wait list according to the ITU Points list as of 25 days before the first competition day.
- c.) 20 days before the first competition day, 5 more athletes from the waitlist will be added to both the men's and women's start list with the most points from the current ITU Points List;
- d.) National Federation quota in each of the men's and women's event:
- (i) Maximum per National Federation and host National Federation is 6 athletes;
 - (ii) Maximum per National Federation and host National Federation may be increased by a maximum of 4 quota places if at any moment of the process the number of athletes on the start list is lower than 70.
- e.) Late Entries: Entries received 25 or fewer days before the first competition day will be placed at the bottom of the wait list at the time the National Federation entered the athlete into the ITU online entry system;
- f.) Invitations: 20 days before the first competition day, the ITU invitation panel will award a maximum of 5 invitations based on, but not limited to, the requests emailed by respective National Federations to entries@triathlon.org and they will be put on the start list. If the ITU invitation panel awards less than 5 invitations, the remaining spot will be filled by the next athlete on the wait list:
- (i) The ITU Invitation Panel is composed by:
 - The ITU Secretary General;
 - A representative of the ITU Sport Department;
 - A representative of ITU Development.
- g.) Substitutions: Each National Federation will be allowed to substitute 1 athlete per gender per event. The names of both athletes involved in the substitution must be emailed to entries@triathlon.org. 1 extra substitution is allowed if the substituted athlete is entered in the ITU Triathlon U23 World Championships instead of the elite events of the ITU World Triathlon Series Grand Final. Substitutions are only allowed up to 12 days prior to the first competition day;
- h.) Athletes exceeding the maximum National Federation quota will be admitted in the start list only if no other athletes remain in the waiting list. The acceptance of athletes exceeding the NF quota will follow the order of one athlete per NF, according to their positions in the waiting list. Once all affected NFs will have one more athlete than the maximum NF quota in the start list, the second exceeding athletes will be moved to the start list, etc.
- i.) Withdrawals: An athlete who is withdrawn from the start list will be replaced by the next athlete on the wait list. According to the rule 2.6.c) (iii) Athletes not attending the briefing, without informing the TD about their absence, will be removed from the start list. In this case, athletes from the wait list who attended the briefing will be called to fill the empty spots. Athletes present in the race briefing and still remaining on the wait list

must stay nearby and in close contact in order to take the place of any upcoming withdrawals, until registration closes;

- j.) The athletes' Briefing: will take place at 18:00, 2 days before the first day of competition;
- k.) If a National Federation withdraws an athlete from the start list within 20 days of the first day of competition they must email entries@triathlon.org. If there is a second withdrawal within 20 days of the first day of competition by the same National Federation, the country will lose 1 quota spot for the following 2 ITU World Triathlon Series events and the maximum quota of the National Federations affected will be adjusted accordingly for those events. **This penalty will be applied from the day of the race briefing and to the 2 next WTS events which has not the start list created.** This penalty will carry over to the following year if occurs near the end of the season;
- l.) National Federations withdrawing an athlete from the start list after the Monday at 13:00 GMT prior to the event, the athlete will be removed from all start lists and wait lists of any ITU events for the next 30 days and will not be reinstated in any of the races on the same weekend as the race from which they were withdrawn.
- m.) A number of unexpected withdrawals without being penalised because last minute issues are fixed. **This benefit extends for both athletes and NFs penalties.** The number depends on the number of participations of each NF the previous year, as follows:

Number of late withdrawals not penalised (*)	Nations (*)
6	AUS, GBR, GER, JPN, RUS, USA
5	ESP, NZL
3	CAN, FRA, POR, RSA, SUI
2	All the others

(*) This includes men and women events in all WTS events, the Grand Final and World Cup events.

- n.) Athletes not personally present at the Athletes' Briefing and who have not provided prior notification to the Technical Delegate by email or by phone will be removed from all start lists and wait lists of any ITU events for the next 30 days and will not be reinstated in any of the races on the same weekend as the race from which they were withdrawn;
- o.) Athletes present at the Athletes' Briefing but are forced to withdraw from the competition due to last minute illness or injury, as proven by a certificate from a medical doctor, will remain on future start lists and wait lists of all ITU events.

2. UNDER23:

- a.) The National Federations must enter their athletes into the wait list via the ITU online entry system no fewer than 33 days before the first competition day;
- b.) 32 days before the first competition day the start lists will be done considering the following qualification principles:
 - (i) Each National Federation in good standing with ITU has the right automatically to enter 2 athletes in the ITU Triathlon U23 World Championships;
 - (ii) Based on the number of athletes the National Federations had in the previous year's ITU Triathlon U23 World Championships results, they will be allowed 1 additional entry for a maximum of 3 in total per National Federation, if the NF had 2 or more athletes in the top 25 of the previous year's ITU Triathlon U23 World Championships.

- c.) Invitations places may be awarded to athlete by the ITU invitation panel upon request emailed by respective National Federations to entries@triathlon.org no later than 26 days prior to the ITU Triathlon U23 World Championships. Invitation places will be awarded 25 days prior to the ITU Triathlon U23 World Championships. The ITU invitation panel shall have the sole authority to award any or all of the invitation places:
- (i) The ITU Invitation Panel is composed by:
- The ITU Secretary General;
 - A representative of the ITU Sport Department;
 - A representative of ITU Development.
- d.) If the number of athletes entered 32 days before the race is less than 70, National Federations can apply for maximum 2 more invitations exceeding their maximum quotas.

3. JUNIOR:

- a.) The National Federations must enter their athletes into the wait list via the ITU online entry system no fewer than 33 days before the first competition day;
- b.) 32 days before the first competition day the start lists will be done considering the following qualification principles:
- (i) The quota system for allocating the spots 1 to 70 is determined on the basis of the 5 continental confederations quotas;
- (ii) The following were considered to create continental quotas:
- The number of National Federations affiliated with ITU within the continent;
 - The number of National Federations that participated in the previous 2 ITU Triathlon Junior World Championships;
 - The number of National Federations that participated in the previous ITU Triathlon Junior Continental Championships.
- (iii) Quotas per Continent (total: 70):
- Africa: 4;
 - Americas: 15;
 - Asia: 9;
 - Europe: 36;
 - Oceania: 6;
 - National Federation Maximum quota: 3.
- c.) The Continental Championships considered as selection events have to take place a minimum of 45 days prior to the ITU Triathlon Junior World Championships. In case the ITU Triathlon Junior Continental Championships will take place after the 45 days term previously indicated, the Continental Confederation can apply to ITU to give the junior continental qualification status to another event. Spots will be awarded on a simple roll-down system through the results. As soon as a National Federation has 3 spots, additional spots will go to the next eligible National Federation on the results lists. Any place not claimed by a National Federation by entering the athlete through the ITU online entry system before 32 days of the ITU Triathlon Junior World Championships will be given to the Invitation places;
- d.) Host National Federation (spot 71 – if required): The host National Federation will get a minimum of 1 spot. If the host National Federation already has a spot from the ITU Triathlon Junior Continental Championships, the spot will go to the Invitation places;

- e.) Invitation: (spots 72 to 75): At the discretion of the ITU invitation panel, spots may be earned based on an athlete's past results and/or current rankings. This could include, but is not limited to, mechanical difficulties or illness at the ITU Triathlon Junior Continental Championships. National Federations must apply for an Invitational spot by email to entries@triathlon.org at least 26 days before the first competition day. Invitations will be awarded 25 days before the first competition day:
- (i) The ITU Invitation Panel is composed by:
- The ITU Secretary General;
 - A representative of the ITU Sport Department;
 - A representative of ITU Development.
- f.) If the number of athletes entered 32 days before the race is less than 70, National Federations can apply for maximum 2 more invitations exceeding their maximum quotas.

4. AGE GROUPS:

- a.) Standard distance:
- (i) Qualification for the ITU Triathlon Age Group World Championships standard distance will be:
- Every National Federation can enter 20 athletes in every Age Group;
 - The host National Federation has a larger quota of 25 athletes in every Age Group;
 - The quota for any National Federation in any Age Group can be increased at the discretion of the ITU invitation panel.
- b.) Sprint distance:
- (i) Qualification for the ITU Triathlon Age Group World Championships Sprint distance will be:
- Every National Federation can enter 20 athletes in every Age Group;
 - The host National Federation has a larger quota of 25 athletes in every Age Group;
 - The quota for any National Federation in any Age Group can be increased at the discretion of the ITU invitation panel.
- c.) The ITU Invitation Panel is composed by:
- (i) ITU Secretary General;
- (ii) A representative of the ITU Sport Department;
- (iii) A representative of ITU Development;

Appendix E2

ITU Triathlon World Cup QUALIFICATION CRITERIA

1. ITU TRIATHLON WORLD CUP EVENTS

- a) The National Federations must enter the athletes into the wait list via the ITU online entry system no less than 33 days before the first competition day;
- b) 32 days before the first competition day, the men's and women's start lists containing up to 70 athletes, will be published on www.competitions.org and adds athletes from the waitlist in the following order:
 - (i) The athletes with the most points from the current ITU Points List;
 - (ii) The rest of the athletes sorted according to the NF alphabetical order starting by the host NF;
 - (iii) The athletes exceeding 70 will remain on the wait list, in the same order indicated in (i) and (ii) above.
- c) National Federation quota in each of the men's and women's event:
 - (i) Maximum per National Federation is 6 athletes;
 - (ii) Maximum per host National Federation is 8 athletes;
 - (iii) Maximum per National Federation and host National Federation may be increased by a maximum of 4 quota places if at any moment of the process the number of athletes on the start list is lower than 70.
- d) Late Entries: Entries received 32 or fewer days before the first competition day will be placed at the bottom of the wait list at the time the National Federation entered the athlete into the ITU online entry system;
- e) Invitations: 26 days before the first competition day, the ITU invitation panel will award invitations based on, but not limited to, the requests emailed by respective National Federations to entries@triathlon.org and they will be moved to the start list. The National Federation quota may be increased by a maximum of 2 more by awarding invitations:
 - (i) The ITU Invitation Panel is composed by:
 - The ITU Secretary General;
 - A representative of the ITU Sport Department;
 - A representative of ITU Development.
- f) Substitutions: Each National Federation will be allowed to substitute 2 athletes per gender per event. The names of the athletes involved in the substitution must be emailed to entries@triathlon.org;
- g) Athletes exceeding the maximum National Federation quota will be admitted in the start list only if no other athletes remain in the waiting list. The acceptance of athletes exceeding the NF quota will follow the order of one athlete per NF, according to their positions in the waiting list. Once all affected NFs will have one more athlete than the maximum NF quota in the start list, the second exceeding athletes will be moved to the start list, etc.
- h) Withdrawals: An athlete who is withdrawn from the start list will be replaced by the next athlete on the wait list. According to the rule 2.6.c) (iii) Athletes not attending the briefing, without informing the TD about their absence, will be removed from the start list. In this case, athletes from the wait list who attended the briefing will be called to fill the empty spots. Athletes present in the race briefing and still remaining on the wait list

must stay nearby and in close contact in order to take the place of any upcoming withdrawals;

- i) National Federations withdrawing an athlete from the start list after the Monday at 13:00 GMT prior to the event, the athlete will be removed from all start lists and wait lists of all ITU events for the next 30 days and will not be reinstated in any of the races on the same weekend as the race from which they were withdrawn; A number of unexpected withdrawals without being penalised because last minute issues are fixed. The number depends on the number of participations of each NF the previous year, as follows:

Number of late withdrawals not penalised (*)	National Federations
6	AUS, GBR, GER, JPN, RUS, USA
5	ESP, NZL
3	CAN, FRA, POR, RSA, SUI
2	All the others

(*) This includes men and women events in all WTS events, the Grand Final and World Cup events.

- j) Athletes not personally present at the Athletes' Briefing and who have not provided prior notification to the Technical Delegate by email or by phone will be removed from all start lists and wait lists of all ITU events for the next 30 days and will not be reinstated in any of the races on the same weekend as the race from which they were withdrawn.
- k) Athletes present at the Athletes' Briefing but are forced to withdraw from the competition due to last minute illness or injury, as proven by a certificate from a medical doctor, will remain on future start lists and wait lists of all ITU events.

Appendix E3

ITU Triathlon Continental Cup QUALIFICATION CRITERIA

1. ITU Triathlon Continental Cup events:

- a) The National Federations must enter the athletes into the wait list via the ITU online entry system no less than 33 days before the first competition day;
- b) 32 days before the first competition day, the men's and women's start lists containing a maximum of 68 athletes will be published on www.triathlon.org. The athletes will be selected according to the following order:
 - (i) Athletes with the most points from the current ITU Points List;
 - (ii) Athletes with the best ranking from the current ITU Continental Points List (the continent where the event is held),
 - (iii) Athletes on the waiting list not present on the current ITU Points List and not present on the current ITU Continental Points List (the continent where the event is held) will be ordered at by choosing one per nation in alphabetical order of the Nation Code starting by the host Nation;
 - (iv) The athletes exceeding 68 will remain in the waiting list, in the same order indicated in (i), (ii) and (iii) above.
- c) National Federation quota in each of the men's and women's event:
 - (i) Maximum per National Federation is 10 athletes;
 - (ii) Maximum per host National Federation is 15 athletes;
 - (iii) Maximum per National Federation and host National Federation may be increased if at any moment of the process the number of athletes on the start list is less than 68.
- d) Late Entries: Entries received 31 or fewer days before the first competition day will be placed at the bottom of the wait list at the time the National federation entered the athlete into the ITU online entry system;
- e) Invitations: 26 days before the first competition day, the ITU invitation panel will award invitations based on, but not limited to, the requests emailed by respective National Federations to entries@triathlon.org and they will be moved to the start list. The National Federation quota may be increased by being awarded invitations;
 - (i) The ITU Invitation Panel is composed by:
 - The Continental Confederation Secretary General;
 - A representative of ITU Sport Department;
 - A representative of Continental Confederation Development.
- f) Substitutions: Each National Federation will be allowed to substitute three athletes per event per gender. The names of the athletes involved in the substitution must be emailed to entries@triathlon.org;
- g) Athletes exceeding the maximum National Federation quota will be admitted in the start list only if no other athletes remain in the waiting list. The acceptance of athletes exceeding the NF quota will follow the order of one athlete per NF, according to their positions in the waiting list. Once all affected NFs will have one more athlete than the maximum NF quota in the start list, the second exceeding athletes will be moved to the start list, etc.
- h) Withdrawals: An athlete withdrawn from the start list will be replaced by the next athlete on the wait list;
- i) National Federations withdrawing athletes from the start list after the Monday at 13:00 GMT prior to the event, the athlete will be removed from all start lists and wait lists of all ITU events for the next 30 days and will not be reinstated in any of the races on the same

- weekend as the race from which they were withdrawn;
- j) Athlete not personally present at the Athletes' Briefing and who have not provided prior notification to the Technical Delegate by email or by phone will be removed from all start lists and wait lists of all ITU events for the next 30 days and will not be reinstated in any of the races on the same weekend as the race from which they were withdrawn;
 - k) Athletes present at the Athletes' Briefing but are forced to withdraw from the competition due to last minute illness or injury, as proven by a certificate from a medical doctor, will remain on future start lists and wait lists of all ITU events;

Appendix E4

ITU Aquathlon World Championships QUALIFICATION CRITERIA

1. ELITE:

- 1.1. National Federation quota for the ITU Elite Aquathlon World Championships in each of the men's and women's event:
 - a) Maximum per National Federation is 6 athletes;
 - b) All qualified athletes for the ITU Elite Aquathlon World Championships need to be entered through their National Federations;
 - c) The quota for any National Federation can be increased at the discretion of the ITU invitation panel.

2. UNDER23:

- 2.1. National Federation quota for the ITU Aquathlon U23 World Championships in each of the men's and women's event:
 - a) Maximum per National Federation is 6 athletes;
 - b) All qualified athletes for the ITU Aquathlon U23 World Championships need to be entered through their National Federations;
 - c) The quota for any National Federation can be increased at the discretion of the ITU invitation panel.

3. JUNIOR:

- 3.1. National Federation quota for the ITU Aquathlon Junior World Championships in each of the men's and women's event:
 - a) Maximum per National Federation is 6 athletes;
 - b) All qualified athletes for the ITU Aquathlon Junior World Championships need to be entered through their National Federations;
 - c) The quota for any National Federation can be increased at the discretion of the ITU invitation panel.

4. AGE GROUPS:

- 4.1. Qualification for the ITU Aquathlon Age Group World Championships will be:
 - a) Every National Federation can enter 20 athletes in every Age Group;
 - b) The host National Federation has a larger quota of 25 athletes in every Age Group;
 - c) All qualified athletes for the ITU Aquathlon Age Group World Championships need to be entered through their National Federations;
 - d) The quota for any National Federation in any Age Group can be increased at the discretion of the ITU invitation panel.

5. PARATRIATHLON:

- 5.1. Qualification to the ITU Paratriathlon Aquathlon World Championships will be:
 - a) Every National Federation can enter 6 athletes in every Paratriathlon Sport Class;
 - b) The host National Federation has a larger quota of 8 athletes in every Paratriathlon Sport Class;
 - c) All qualified athletes for the ITU Paratriathlon Aquathlon World Championships need to be entered through their National Federations;
 - d) The quota for any National Federation in any Paratriathlon Sport Class can be increased at the discretion of the ITU invitation panel.

6. DEADLINES:

- 6.1. The National Federations must enter the athletes into the wait list via the ITU online entry system no less than 33 days before the first competition day;
- 6.2. 32 days before the first competition day, all the start lists will be published on www.triathlon.org.

7. INVITATION PANEL:

- 7.1 The ITU Invitation Panel is composed by:
 - a) The ITU Secretary General;
 - b.) A representative of the ITU Sport Department;
 - c.) A representative of ITU Development.

Appendix E5

ITU Cross Triathlon World Championships QUALIFICATION CRITERIA

1. ELITE:

- 1.1. National Federation quota for the ITU Elite Cross Triathlon World Championships in each of the men's and women's event:
 - a) Maximum per National Federation is 6 athletes;
 - b) All qualified athletes for the ITU Elite Cross Triathlon World Championships need to be entered through their National Federations;
 - c) The quota for any National Federation can be increased at the discretion of the ITU invitation panel.

2. UNDER23:

- 2.1. National Federation quota for the ITU Cross Triathlon U23 World Championships in each of the men's and women's event:
 - a) Maximum per National Federation is 6 athletes;
 - b) All qualified athletes for the ITU Cross Triathlon U23 World Championships need to be entered through their National Federations;
 - c) The quota for any National Federation can be increased at the discretion of the ITU invitation panel.

3. JUNIOR:

- 3.1. National Federation quota for the ITU Cross Triathlon Junior World Championships in each of the men's and women's event:
 - a) Maximum per National Federation is 6 athletes;
 - b) All qualified athletes for the ITU Cross Triathlon Junior World Championships need to be entered through their National Federations;
 - c) The quota for any National Federation can be increased at the discretion of the ITU invitation panel.

4. AGE GROUPS:

- 4.1. Qualification for the ITU Cross Triathlon Age Group World Championships will be:
 - a) Every National Federation can enter 20 athletes in every Age Group;
 - b) The host National Federation has a larger quota of 25 athletes in every Age Group;
 - c) All qualified athletes for the ITU Cross Triathlon Age Group World Championships need to be entered through their National Federations;
 - d) The quota for any National Federation in any Age Group can be increased at the discretion of the ITU invitation panel.

5. PARATRIATHLON:

- 5.1. Qualification to the ITU Paratriathlon Cross Triathlon World Championships will be:
 - a) Every National Federation can enter 6 athletes in every Paratriathlon Sport Class;
 - b) The host National Federation has a larger quota of 8 athletes in every eligible Paratriathlon Sport Class;
 - c) All qualified athletes for the ITU Paratriathlon Cross Triathlon World Championships need to be entered through their National Federations;
 - d) The quota for any National Federation in any Paratriathlon Sport Class can be increased at the discretion of the ITU invitation panel.

6. DEADLINES:

- 6.1. The National Federations must enter the athletes into the wait list via the ITU online entry system no less than 33 days before the first competition day;
- 6.2. 32 days before the first competition day, all the start lists will be published on www.triathlon.org.

7. INVITATION PANEL:

- 7.1 The ITU Invitation Panel is composed by:
 - a) The ITU Secretary General;
 - b.) A representative of the ITU Sport Department;
 - c.) A representative of ITU Development.

Appendix E6

ITU Duathlon World Championships QUALIFICATION CRITERIA

1. ELITE:

- 1.1. National Federation quota for the ITU Elite Duathlon World Championships in each of the men's and women's event:
 - a) Maximum per National Federation is 6 athletes;
 - b) All qualified athletes for the ITU Elite Duathlon World Championships need to be entered through their National Federations;
 - c) The quota for any National Federation can be increased at the discretion of the ITU invitation panel.

2. UNDER23:

- 2.1. National Federation quota for the ITU Duathlon U23 World Championships in each of the men's and women's event:
 - a) Maximum per National Federation is 6 athletes;
 - b) All qualified athletes for the ITU Duathlon U23 World Championships need to be entered through their National Federations;
 - c) The quota for any National Federation can be increased at the discretion of the ITU invitation panel.

3. JUNIOR:

- 3.1. National Federation quota for the ITU Duathlon Junior World Championships in each of the men's and women's event:
 - a) Maximum per National Federation is 6 athletes;
 - b) All qualified athletes for the ITU Duathlon Junior World Championships need to be entered through their National Federations;
 - c) The quota for any National Federation can be increased at the discretion of the ITU invitation panel.

4. AGE GROUPS:

- 4.1. Qualification for the ITU Duathlon Age Group World Championships will be:
 - a) Every National Federation can enter 20 athletes in every Age Group;
 - b) The host National Federation has a larger quota of 25 athletes in every Age Group;
 - c) All qualified athletes for the ITU Duathlon Age Group World Championships need to be entered through their National Federations;
 - d) The quota for any National Federation in any Age Group can be increased at the discretion of the ITU invitation panel.

5. PARATRIATHLON:

- 5.1. Qualification to the ITU Paratriathlon Duathlon World Championships will be:
 - a) Every National Federation can enter 6 athletes in every Paratriathlon Sport Class;
 - b) The host National Federation has a larger quota of 8 athletes in every Paratriathlon Sport Class;
 - c) All qualified athletes for the ITU Paratriathlon Duathlon World Championships need to be entered through their National Federations;
 - d) The quota for any National Federation in any Paratriathlon Sport Class can be increased at the discretion of the ITU invitation panel.

6. DEADLINES:

- 6.1. The National Federations must enter the athletes into the wait list via the ITU online entry system no less than 33 days before the first competition day;
- 6.2. 32 days before the first competition day, all the start lists will be published on www.triathlon.org

7. INVITATION PANEL:

- 7.1 The ITU Invitation Panel is composed by:
 - a) The ITU Secretary General;
 - b) A representative of the ITU Sport Department;
 - c) A representative of ITU Development.

Appendix E7

ITU Long Distance Duathlon World Championships QUALIFICATION CRITERIA

1. ELITE:

- 1.1. National Federation quota for the ITU Elite Long Distance Duathlon World Championships in each of the men's and women's event:
 - a) Maximum per National Federation is 6 athletes;
 - b) All qualified athletes for the ITU Elite Long Distance Duathlon World Championships need to be entered through their National Federations;
 - c) The quota of any National Federation can be increased at the discretion of the ITU invitation panel.

2. AGE GROUPS:

- 2.1. Qualification for the ITU Long Distance Duathlon Age Group World Championships will be:
 - a) Every National Federation can enter 20 athletes in every Age Group;
 - b) The host National Federation has a larger quota of 25 athletes in every Age Group;
 - c) All qualified athletes for the ITU Long Distance Duathlon Age Group World Championships need to be entered through their National Federations;
 - d) The quota for any National Federation in any Age Group can be increased at the discretion of the ITU invitation panel.

3. PARATRIATHLON:

- 3.1. Qualification to the ITU Paratriathlon Long Distance Duathlon World Championships will be:
 - a) Every National Federation can enter 6 athletes in every Paratriathlon Sport Class;
 - b) The host National Federation has a larger quota of 8 athletes in every Paratriathlon Sport Class;
 - c) All qualified athletes for the ITU Paratriathlon Long Distance Duathlon World Championships need to be entered through their National Federations;
 - d) The quota for any National Federation in any Paratriathlon Sport Class can be increased at the discretion of the ITU invitation panel.

4. DEADLINES:

- 4.1. The National Federations must enter the athletes into the wait list via the ITU online entry system no less than 90 days before the first competition day, for the Age Group athletes, and 33 days for Elite and Paratriathlon athletes;
- 4.2. One day after the deadline above indicated, the start lists will be published on www.triathlon.org.

5. INVITATION PANEL:

- 5.1 The ITU Invitation Panel is composed by:
 - a) The ITU Secretary General;
 - b) A representative of the ITU Sport Department;
 - c) A representative of ITU Development.

Appendix E8

ITU Long Distance Triathlon World Championships QUALIFICATION CRITERIA

1. ELITE:

- 1.1. National Federation quota for the ITU Elite Long Distance Triathlon World Championships in each of the men's and women's event:
 - a) Maximum per National Federation is 6 athletes;
 - b) All qualified athletes for the ITU Elite Long Distance Triathlon World Championships need to be entered through their National Federations;
 - c) The quota for any National Federation can be increased at the discretion of the ITU invitation panel.

2. AGE GROUPS:

- 2.1. Qualification for the ITU Long Distance Triathlon Age Group World Championships will be:
 - a) Every National Federation can enter 20 athletes in every Age Group;
 - b) The host National Federation has a larger quota of 25 athletes in every Age Group;
 - c) All qualified athletes for the ITU Long Distance Triathlon Age Group World Championships need to be entered through their National Federations;
 - d) The quota for any National Federation in any Age Group can be increased at the discretion of the ITU invitation panel.

3. PARATRIATHLON:

- 3.1. Qualification to the ITU Paratriathlon Long Distance Triathlon World Championships will be:
 - a) Every National Federation can enter 6 athletes in every Paratriathlon Sport Class;
 - b) The host National Federation has a larger quota of 8 athletes in every Paratriathlon Sport Class;
 - c) All qualified athletes for the ITU Paratriathlon Long Distance Triathlon World Championships to be entered through their National Federations;
 - d) The quota for any National Federation in any Paratriathlon Sport Class can be increased at the discretion of the ITU invitation panel.

4. DEADLINES:

- 4.1. The National Federations must enter the athletes into the wait list via the ITU online entry system no less than 90 days before the first competition day, for the Age Group athletes, and 33 days for Elite and Paratriathlon athletes;
- 4.2. One day after the deadline above indicated, the start lists will be published on www.triathlon.org.

5. INVITATION PANEL:

- 5.1. The ITU Invitation Panel is composed by:
 - a) The ITU Secretary General;
 - b) A representative of the ITU Sport Department;
 - c) A representative of ITU Development

Appendix E9

ITU Winter Triathlon World Championships QUALIFICATION CRITERIA

1. ELITE:

- 1.1. National Federation quota for the ITU Elite Winter Triathlon World Championships in each of the men's and women's event:
 - a) Maximum per National Federation is 6 athletes;
 - b) All qualified athletes for the ITU Elite Winter Triathlon World Championships need to be entered through their National Federations;
 - c) The quota for any National Federation can be increased at the discretion of the ITU invitation panel.

2. UNDER 23:

- 2.1. National Federation quota for the ITU Winter Triathlon U23 World Championships in each of the men's and women's event:
 - a) Maximum per National Federation is 6 athletes;
 - b) All qualified athletes for the ITU Winter Triathlon U23 World Championships need to be entered through their National Federations;
 - c) The quota for any National Federation can be increased at the discretion of ITU invitation panel.

3. JUNIOR:

- 3.1. National Federation quota for the ITU Winter Triathlon Junior World Championships in each of the men's and women's event:
 - a) Maximum per National Federation is 6 athletes;
 - b) All qualified athletes for the ITU Winter Triathlon Junior World Championships need to be entered through their National Federations;
 - c) The quota for any National Federation can be increased at the discretion of the ITU invitation panel.

4. AGE GROUPS:

- 4.1. Qualification for the ITU Winter Triathlon Age Group World Championships will be:
 - a) Every National Federation can enter 20 athletes in every Age Group;
 - b) The host National Federation has a larger quota of 25 athletes in every Age Group;
 - c) All qualified athletes for the ITU Winter Triathlon Age Group World Championships need to be entered through their National Federations;
 - d) The quota for any National Federation in any Age Group can be increased at the discretion of the ITU invitation panel.

5. PARATRIATHLON:

- 5.1. Qualification to the ITU Paratriathlon Winter Triathlon World Championships will be:
 - a) Every National Federation can enter 6 athletes in every eligible Paratriathlon Sport Class;
 - b) The host National Federation has a larger quota of 8 athletes in every eligible Paratriathlon Sport Class;
 - c) All qualified athletes for the ITU Paratriathlon Winter Triathlon World Championships need to be entered through their National Federations;
 - d) The quota for any National Federation in any Paratriathlon Sport Class can be increased at the discretion of the ITU invitation panel.

6. DEADLINES:

- 6.1. The National Federations must enter the athletes into the wait list via the ITU online entry system no less than 33 days before the first competition day;
- 6.2. 32 days before the first competition day, all the start lists will be published on www.triathlon.org.

7. INVITATION PANEL:

- 7.1. The ITU Invitation Panel is composed by:
 - a) The ITU Secretary General;
 - b) A representative of the ITU Sport Department;
 - c) A representative of ITU Development.

Appendix E1o

ITU Triathlon Mixed Relay World Championships QUALIFICATION CRITERIA

1. The National Federations must enter a maximum of one team into the wait list via the ITU online entry system no less than 60 days before the competition; 59 days before the competition, the team start list will be published on www.triathlon.org and teams will be added from the wait list in the following order: The team of the host nation;
 - 2.2. Teams that finished in the top eleven (11) positions in the previous ITU Triathlon Mixed Relay World Championships. If the host nation is among these, the twelfth team will be moved to the start list;
 - 2.3. The top team from each Continental Championship/Continental Qualifier event, excluding the teams that previously qualified according to 2.1 and 2.2.
3. The remaining teams in the wait list will be sorted according to the results in their Continental Championships/Continental Qualifier event. Teams that withdraw from the race will be replaced by the next in the wait list from the same continent. If there are none, the replacement team will be the highest ranked in the Continental Championship/Continental Qualifier event, in case of same position, the first entered in the wait list;
4. Late Entries: Entries received 59 or fewer days before the first competition day will be placed at the bottom of the wait list at the time the National Federation entered the team into the ITU online entry system;
5. Invitations: 55 days before the competition day, the ITU Invitation Panel will award invitations up to 20 teams in the start list, based on the requests emailed by respective National Federations to entries@triathlon.org. Continents that do not have a Continental Championship/Continental Qualifier event will be prioritised in the allocation of invitations:
 - 5.1. The ITU Invitation Panel is composed by:
 - a.) The ITU Secretary General;
 - b.) A representative of the ITU Sport Department;
 - c.) A representative of ITU Development.

Appendix E11

ITU Triathlon U23/JN Mixed Relay World Championships QUALIFICATION CRITERIA

1. Age eligibility. All team members must belong either the Junior or the U23 category, as defined in ITU Competition Rules 2.5;
2. The National Federations must enter a maximum of two teams into the wait list via the ITU online entry system no less than 60 days before the competition;
3. 59 days before the competition, the team start list will be published on www.triathlon.org and teams will be added from the wait list in the following order:
 - 3.1 The team of the host nation;
 - 3.2 Teams that finished in the top eleven (11) positions in the previous ITU Triathlon U23/JN Mixed Relay World Championships. If the host nation is among these, the twelfth team will be moved to the start list;
 - 3.3 The remaining teams will remain in the wait list.
4. Invitations: 55 days before the competition day, the ITU invitation panel will award invitations up to a total of 20 teams in the start list, and will produce a wait list sorted, provided that all the NFs second teams will be placed after all the NFs first teams. NFs can request invitations by email to entries@triathlon.org. The ITU invitation panel may include teams in the start list, even if the NF did not submit any request. The ITU invitation panel will warranty that all 5 continents will have at least one team included in the start list;
5. Late entries:
 - 5.1 Late entries received between the publication of the start list and the invitation panel meeting will be added to the wait list;
 - 5.2 Late entries received after the invitation panel meeting, will be included at the end of the wait list, provided that all the NFs second teams will be placed after all the NFs first teams.
6. Withdrawals:
 - 6.1 Withdrawals received between the publication of the start list and the invitation panel meeting will be filled during the invitation process;
 - 6.2 Withdrawals received after the invitation panel meeting will be filled by the next team on the wait list.
7. The ITU Invitation Panel is composed of:
 - The ITU Secretary General;
 - A representative of the ITU Sport Department;
 - A representative of ITU Development.

Appendix E12

ITU Paratriathlon Events QUALIFICATION CRITERIA

1. ELITE PARATRIATHLON:

1.1. Number of participants:

a.) The maximum number of participants will be:

Category of event	Maximum Participants	Qualified by Criteria	Invitations	NF Quota / Sport Class
World Championships	100	90	10	2 (Host NF +1)
Continental Championships	70	60	10	2 (Host NF + 1)
World Paratriathlon Events	60	50	10	2 (Host NF +1)

b.) Depending on the conditions of the event, the TD may fix a maximum quota in the Sport Classes PT-1 and PT-5;

c.) At the end of the season, ITU will review the quota distribution amongst the different sport classes and gender. This distribution will be in principle based on the number of Paratriathletes present in the ITU Paratriathlon Points List. The 2016 distribution will be as follows:

2016	PT1		PT2		PT3		PT4		PT5		TOT
	M	W	M	W	M	W	M	W	M	W	
WPE	6	3	5	3	5	3	11	5	5	4	50
CCHs	7	4	6	4	6	3	13	6	6	5	60
WCHs	10	5	10	7	7	4	17	10	10	10	90

d.) Each sport class will be provided with minimum of 3 Paratriathletes per gender;

e.) If the start list of the sport class is not full, all the remaining places for that sport class will go to the invitations.

1.2. Eligibility:

a.) ITU World Championships: athletes must have a "Provisional Classification Status" (PCS), "Review" (R) or "Confirmed" (C) classification status on the ITU Classification Master List at the time of the production of the start lists. No classification will be offered on site, except for Review "R" cases or protests;

b.) For all other ITU paratriathlon events, athletes must have a "Provisional Classification Status" (PCS), "Review" (R) or "Confirmed" (C) classification status at the time of the production of the start list or if entered as "New" (N) or "Provisional Competition Status" (PCR), must undergo classification if available at the event.

- 1.3. Start lists and wait lists:
- a.) The National Federations must enter the athletes into the wait list via the ITU online entry system no fewer than 33 days before the first competition day;
 - b.) 32 days before the first competition day, the start list for all sport classes events will be published on www.triathlon.org adding athletes from the waitlist in the following order:
 - (i) Athletes with the most points from the current ITU Paratriathlon World Ranking in the given sport class up to the maximum number set by the quota distribution;
 - (ii) The remaining place(s) – if any – will be distributed one per NF, before considering the second slot from the same NF. The order between the NFs will be in alphabetical order (NOC code) starting with the host NF;
 - (iii) National Federations must indicate the priority order of their athletes for the production of start list, for those without ranking points. If there is no priority order assigned by the National Federation a draw will be conducted;
 - (iv) Two common wait lists (one for men, one for women) will be prepared and sorted by points in the ITU Paratriathlon Points Lists for athletes who cannot be selected according to the quota distribution (either sport class or NF). Athletes without points will be sorted as indicated in letters (ii) and (iii) above;
 - (v) Late Entries: Entries received 32 or fewer days before the first competition day will be placed at the bottom of the wait list at the time the National Federation entered the athlete into the ITU online entry system.
 - c.) National Federation maximum quota per sport class is outlined in 1.1.a.);
 - d.) The maximum NFs' quotas may be exceeded if the start list of the sport class is not full. The acceptance of athletes exceeding the NF quota for that sport class will follow the order of 1 athlete per NF, by NF code alphabetical order, starting with the host Nation;
 - e.) Substitutions: Each National Federation will be allowed to substitute 1 athlete per sport class. The names of both athletes involved in the substitution must be emailed to entries@triathlon.org Substitutions are only allowed until 12 days prior to the first competition day;
 - l) Withdrawals: An athlete who is withdrawn from the start list will be replaced by the next athlete on the same gender wait list, if exists. Athletes exceeding the NF/Sport class quota will not be eligible for this replacement while there will be athletes on the wait list not exceeding the NF/sport class quota. According to ITU Competition Rule 2.7.b) (iv): *Athletes not attending the briefing, without informing the TD about their absence, will be removed from the start list.* In this case, athletes from the wait list, who attended the briefing, will be offered the unused slots. Athletes present in the race briefing, and still remaining on the wait list, must make themselves available, and their guide or handler(s) directly to the Technical Delegate and Race Referee in order to take the place of any upcoming withdrawals, until registration closes;

m) National Federations withdrawing athletes from the start list after the Monday at 13:00 GMT prior to the event, and athletes not attending the briefing without informing the TD about their absence, the athlete involved will be removed from all start lists and wait lists of all ITU events for the next 30 days and will not be reinstated in any of the races on the same weekend as the race from which they were withdrawn;

f.) Invitations: 26 days before the first competition day, the ITU invitation panel will award invitations based on, but not limited to, the requests submitted by respective National Federations to entries@triathlon.org. Athletes awarded with invitations will be immediately moved to the start lists. The National Federation quota and the sport class maximum quota may be increased by awarded invitations;

g.) The ITU Invitation Panel is composed by:

- (i) The ITU Secretary General;
- (ii) A representative of the ITU Sport Department;
- (iii) A representative of ITU Development;

2. **OPEN PARATRIATHLON:**Number of participants:

- a. Every National Federation can enter 6 athletes in every sport class;
- b. The host National Federation has a larger quota of 8 athletes in every sport class;
- c. The quota for any National Federation in any sport class can be increased at the discretion of the ITU invitation Panel.

2.2. Eligibility:

- a. Only Paratriathletes with Provisional "PCS" Review "R" or Confirmed "C" classification status will be eligible to compete.

2.3. Deadlines:

- a. The National Federations must enter the athletes into the wait lists via the ITU online entry system no less than 60 days before the first competition day;
- b. 59 days before the first competition day, all start lists will be published on www.triathlon.org.

Appendix E13

ITU World Triathlon Series - RANKING CRITERIA

1. PURPOSE:

- a) ITU World Triathlon Series Rankings will be used to determine the ITU Triathlon World Champion;
- b) The ITU World Champions will be established at the end of the series and the ITU World Triathlon Series Bonus Pool Prize Money will be distributed after the last scoring event according to the ITU World Triathlon Series Rankings;

2. POINTS AND SCORING:

a) Scoring events:

(i) There will be 3 levels of events included in the ITU World Triathlon Series Rankings:

- The ITU World Triathlon Series Grand Final;
- The ITU World Triathlon Series events;
- The ITU Triathlon World Cup events;

(ii) The points earned by the winner of each event will be:

- 1200 for the ITU World Triathlon Series Grand Final;
- 800 for the ITU World Triathlon Series events;
- 300 for the ITU Triathlon World Cup events;

(iii) The points table for each level of event will be from:

- 1st to 50th for the ITU World Triathlon Series Grand Final;
- 1st to 40th for the ITU World Triathlon Series events;
- 1st to 30th for the ITU Triathlon World Cup events;

(iv) The points will be decreased according to points table below.

- b) **Cut off:** To earn points, athletes must finish within the cut-off time which will be determined by adding 5% to the winner's time in the men's event and 8% in the women's event;
- c) **Races scoring:** The final score will be obtained by adding the points gained in the ITU World Triathlon Series Grand Final plus the 5 best scores in the ITU World Triathlon Series events and the ITU Triathlon World Cup events with the following limitations:
 - (i) A maximum of 2 ITU Triathlon World Cup events scores will count for the final rankings.
- d) The intermediate rankings will be set as follows:

After the ITU WTS event number	Total events to add	Maximum ITU World Cups to count	ITU World Championship Grand Final
1	1	-	-
2	2	-	-
3	3	-	-
4	4	-	-
5	5	-	-
6	5	-	-
7	5	-	-
8	5	-	-
9	5	2	-
After Grand Final	5+Grand Final	2	1

- e) **Season:** The ITU World Triathlon Series season starts immediately after the ITU World Triathlon Grand Final and finishes with the ITU World Triathlon Series Grand Final.

3. POINTS TABLE:

Finish Position	ITU World Triathlon Series Grand Final	ITU World Triathlon Series events	ITU Triathlon World Cup events
1	1200	800	300
2	1110	740	278
3	1027	685	257
4	950	633	237
5	879	586	220
6	813	542	203
7	752	501	188
8	695	464	174
9	643	429	161
10	595	397	149
11	550	367	138
12	509	339	127
13	471	314	118
14	436	290	109
15	403	269	101
16	373	248	93
17	345	230	86
18	319	213	80
19	295	197	74
20	273	182	68
21	252	168	63
22	233	156	58
23	216	144	54
24	200	133	50
25	185	123	46
26	171	114	43
27	158	105	40
28	146	97	37
29	135	90	34
30	125	83	31
31	116	77	-
32	107	71	-
33	99	66	-
34	92	61	-
35	85	56	-
36	78	52	-
37	72	48	-
38	67	44	-
39	62	41	-
40	57	38	-
41	53	-	-
42	49	-	-
43	45	-	-
44	42	-	-
45	39	-	-

46	36	-	-
47	33	-	-
48	30	-	-
49	28	-	-
50	26	-	-

Appendix E14

ITU Points List Criteria

1. PURPOSE:

- 1.1. ITU Points List will be used to determine athletes' eligibility to enter ITU Triathlon World Triathlon Series events, ITU Triathlon World Cup events, and ITU Triathlon Continental Championship events;
- 1.2. Continental Confederations may also use the ITU Points List to determine National Federation quotas for ITU Triathlon Continental Championships;
- 1.3. The ITU Points List will be posted on www.triathlon.org, but will not be considered as a ranking;

2. ELIGIBILITY:

- 2.1. Only athletes in good standing with their National Federation affiliated with ITU are eligible to be included in the ITU Points List.

3. SCORING EVENTS:

3.1. General:

- a) There will be 11 levels of events included in the ITU Points List:
 - The ITU World Triathlon Series Grand Final;
 - The ITU World Triathlon Series events;
 - The ITU Triathlon World Cup events;
 - The ITU Triathlon Continental Championships Standard Distance;
 - The ITU Triathlon Continental Championships Sprint Distance;
 - The ITU Triathlon U23 World Championships;
 - The ITU Triathlon Continental Cup and ITU Triathlon Premium Continental Cup events (these events can be either sprint or standard distance);
 - The Universiade or the FISU Triathlon University World Championships;
 - The ITU Triathlon Junior World Championships;
 - The ITU Triathlon U23 Continental Championships;
 - The ITU Triathlon Junior Continental Championships.
- b) The points earned by the winner of each event will be:
 - 1000 for the ITU World Triathlon Series Grand Final;
 - 750 for the ITU World Triathlon Series events;
 - 500 for the ITU Triathlon World Cup events;
 - 400 for the ITU Triathlon Continental Championships Standard Distance;
 - 300 for the ITU Triathlon Continental Championships Sprint Distance;
 - 200 for the ITU Triathlon U23 World Championships;
 - 200 for the ITU Triathlon Continental Cup and ITU Triathlon Premium Continental Cup events;
 - 200 for the Universiade or the FISU Triathlon University World Championships;
 - 100 for the ITU Triathlon Junior World Championships;

- 100 for the ITU Triathlon U23 Continental Championships;
 - 50 for the ITU Triathlon Junior Continental Championships;
- c) The points table for each level of event will be from:
- 1st to 50th for the ITU World Triathlon Series Grand Final;
 - 1st to 50th for the ITU World Triathlon Series events;
 - 1st to 50th for the ITU Triathlon World Cup events;
 - 1st to 50th for the ITU Triathlon Continental Championships Standard Distance (only athletes from the same continent);
 - 1st to 30th for the ITU Triathlon Continental Championships Sprint Distance (only athletes from the same continent);
 - 1st to 20th for the ITU Triathlon U23 World Championships;
 - 1st to 20th for the ITU Triathlon Continental Cup and ITU Triathlon Premium Continental Cup events;
 - 1st to 20th for the Universiade or the FISU Triathlon University World Championships;
 - 1st to 10th for the ITU Triathlon Junior World Championships;
 - 1st to 10th for the ITU Triathlon U23 Continental Championships;
 - 1st to 10th for the ITU Triathlon Junior Continental Championships;
- d) The points will be decreased by 7.5%.
- 3.2. **Cut-off:** To earn points, athletes must finish within the cut-off time which will be determined by adding 5% to the winner's time in the men's event and 8% in the women's event.
- 3.3. **Quality of field:** Every athlete ranked in the top 20 of the current ITU Points list who starts the race will increase the value of the race by 2% up to a maximum of 20% per event.
- 3.4. **Total Events to Count:**
It will be a maximum of 12 events to count:
- a) 6 from the 52 weeks previous to the date of the publication of the lists (current period);
 - b) 6 from the days between the 53rd and the 104th week previous to the date of publication of the lists (previous period).
- 3.5. The total number of points acquired by an athlete in a given week will be determined by adding the 6 best scores in the current period, plus 1/3 of the addition of the 6 best scores in the previous period. In each of the periods a n athlete may not earn points from more than 3 ITU Triathlon Continental Cup or ITU Triathlon Premium Continental Cup events.

Appendix E15

ITU Continental Points Lists Criteria

1. GENERAL:

- 1.1. There are 5 Continental Points Lists (one per continent: Africa, the Americas, Asia, Europe and Oceania);
- 1.2. The ITU Triathlon Continental Cup events may be categorised into two levels, according to system established by the Continental Confederation (i.e., difference in prize money, in television coverage, etc). The higher level ITU Triathlon Continental Cup events will be called "ITU Triathlon Premium Continental Cup" and the lower level "ITU Triathlon Continental Cup";
- 1.3. The title of the event will have the name of the continent replacing the word, "continent" and the short name of the Continental Confederation, i.e., 2010 Pontevedra ETU Triathlon Premium European Cup.

2. ELIGIBILITY:

- 2.1. Only athletes in good standing with their National Federations affiliated with the Continental Confederation are eligible to be included in the ITU Continental Points Lists from their continent.

3. SCORING EVENTS:

3.1. General:

- a) There will be 6 levels of events included in the ITU Continental Points Lists:
 - The ITU Triathlon Continental Championships (standard distance);
 - The ITU Triathlon Continental Championships (sprint distance);
 - The ITU Triathlon Continental Cup Final events;
 - The ITU Triathlon Premium Continental Cup events;
 - The ITU Triathlon Continental Cup events;
 - The ITU Triathlon U23 Continental Championships;
 - The ITU Triathlon Regional Championships;
 - The ITU Triathlon Junior Continental Championships;
 - The Triathlon National Championships. (*)

(*) Only athletes representing the respective NF will earn points. If the National Federation holds two National Championships, in Standard and Sprint Distance, the Standard Distance Championship will be the one considered.
- b) The points earned by the winner of each event will be:
 - 600 for the ITU Triathlon Continental Championships (standard distance);
 - 450 for the ITU Triathlon Continental Championships (sprint distance);
 - 500 for the ITU Triathlon Continental Cup Final events;
 - 400 for the ITU Triathlon Premium Continental Cup events;
 - 250 for the ITU Triathlon Continental Cup events;
 - 250 for the ITU U23 Triathlon Continental Championships;
 - 150 for the ITU Triathlon Regional Championships;
 - 125 for the ITU Junior Triathlon Continental Championships;
 - 100 for the Triathlon National Championships;
- c) The points table for each level of event will be from:
 - 1st to 40th for the ITU Triathlon Continental Championships (standard distance);

- 1st to 30th for the ITU Triathlon Continental Championships (sprint distance);
 - 1st to 30th for the ITU Continental Cup Final events;
 - 1st to 20th for the ITU Triathlon Premium Continental Cup events;
 - 1st to 20th for the ITU Triathlon Continental Cup events;
 - 1st to 20th for the ITU Triathlon U23 Continental Championships;
 - 1st to 10th for the ITU Triathlon Regional Championships;
 - 1st to 10th for the ITU Triathlon Junior Continental Championships;
 - 1st to 5th for the Triathlon National Championships.
- d) The points will be decreased by 7.5%;
- e) The events included in more than one level (i.e. National Championships taking place in a Continental Cup event) will give only one score to every athlete. If an athlete should gain points by more than one way (i.e. points for the overall event and points for the National Championships) only the highest score will be considered.
- 3.2. **Cut-off:** To earn points, athletes must finish within the cut-off time which will be determined by adding 5% to the winner's time in the men's event and 8% in the women's event;
- 3.3. **Quality of field:** Each athlete starting the race among the top 20 of the current ITU Continental Points Lists will increase the value of the event by 2%. This increase is limited to 20%;
- 3.4. **Total Events to Count:**
It will be a maximum of 10 events to count:
- a) 5 from the 365 days previous to the date of the publication of the list (current period);
 - b) 5 from the days between the 366th and 730th previous to the date of publication of the list (previous period).
- 3.5. **Value of the points depending on the periods:**
- a) The value of the points in the current period is the same as those gained in the event;
 - b) The value of the points in the previous period is 1/3 of those gained in the event.

Appendix E16

ITU Junior Continental Ranking Criteria

1. GENERAL:

- 1.1. There are 2 Junior Continental Rankings: America and Europe.

2. ELIGIBILITY:

- 2.1. Only athletes in good standing with their National Federations affiliated with the Continental Confederation are eligible to be included in the ITU Junior Continental Rankings from their continent.

3. SCORING EVENTS:

3.1. General:

- a) There will be 4 levels of events included in the ITU Junior Continental Ranking:

- The ITU Triathlon Junior Continental Championships;
- The ITU Triathlon Junior Regional Championships
- The ITU Triathlon Junior Continental Cup;
- The Triathlon Junior National Championships.

- b) The points earned by the winner for each event will be:

- 600 for the ITU Triathlon Continental Championships;
- 500 for the ITU Triathlon Junior Regional Championships;
- 400 for the ITU Triathlon Junior Continental Cup;
- 100 for the Triathlon National Championships. (*)

(*) Only athletes representing the respective NF will earn points. If the National Federation holds two National Championships, in Sprint and Super Sprint Distance, the Sprint Distance Championship will be the one considered.

- c) The points table for each level of event will be from:

- 1st to 25th for the ITU Triathlon Junior Continental Championships;
- 1st to 25th for the ITU Junior Regional Championships;
- 1st to 20th for the ITU Triathlon Triathlon Junior Continental Cup;
- 1st to 5th for the Triathlon National Championships.

- d) The points will be decreased by 7.5% (i.e., if the winner of the ITU Continental Championships gets 600 points, the second will get 555.00, the third 513.38, etc.);

- e) The events included in more than one level (i.e. National Championships within a Continental Cup event) will give only one score to every athlete. If an athlete should gain points by more than one way (i.e. points for the overall event and points for the National Championships) only the highest score will be considered.

3.2. **Total Events to Count:**

It will be a maximum of 3 events to count.

3.3. **Validity of the rankings:**

a) The rankings start on January 1st and finish in December 31st of every year.

Appendix E17

ITU Duathlon Points List Criteria

1. PURPOSE:

- 1.1. ITU Duathlon Points Lists will be used to determine the best performing duathletes.

2. POINTS AND SCORING:

2.1. Scoring events:

- a) There will be 6 levels of events included in the ITU World Duathlon Points Lists:
 - The ITU Duathlon World Championships;
 - The ITU Long Distance Duathlon World Championships;
 - The ITU Duathlon World Series events (long and standard distances);
 - The ITU Duathlon Continental Championships events (long and standard distances); (*)
 - The Duathlon National Championships. (**)

(*) Athletes from all the continents are eligible to earn points.

(**) Only athletes representing the respective NF will earn points. If the National Federation holds National Championships, in Standard, Long and/or Sprint Distance, the Standard Distance Championship will be preferred over the Long distance one, and the Long Distance will be preferred over the Sprint distance.

- b) The points earned by the winner of each event will be:
 - 1000 for the ITU Duathlon World Championships (long and standard distances);
 - 600 for the ITU Duathlon Continental Championships (long and standard distances);
 - 400 for the ITU Duathlon World Series events (long and standard distances);
 - 150 for the Duathlon National Championships.
- c) The points table for each level of event will be from:
 - 1st to 25th for the ITU Duathlon World Championships;
 - 1st to 15th for the ITU Long Distance Duathlon World Championships;
 - 1st to 15th for the ITU Duathlon World Series events;
 - 1st to 15th for the ITU Duathlon Continental Championships;
 - 1st to 10th for the ITU Duathlon Continental Cup events;
 - 1st to 5th for the Duathlon National Championships;
- d) The points will be decreased by 7.5% every position;
- e) The events included in more than one level (i.e. National Championships taking place in a Continental Cup event) will give only one score to every athlete. If an athlete should gain points by more than one way (i.e. points for the overall event and points for the National Championships) only the highest score will be considered;

2.2. Total Events to Count:

The total number of points acquired by an athlete in a given year will be the result of adding:

- a) The 5 best scores in the previous 53 weeks (current year);
- b) $\frac{1}{3}$ of the value of the the 5 best scores gained in the weeks between the 54th and the 106th previous to the date of publication. (previous period).

2.3. Value of the points depending on the periods:

- a) The value of the points in the current period will be the same as those gained in the event;
- b) b) The value of the points in the previous period will be $\frac{1}{3}$ of those gained in the event.

Appendix E18

ITU Long Distance Triathlon Points List Criteria

1. PURPOSE:

- 1.1. ITU Long Distance Triathlon Points Lists will be used to determine the best performing long distance triathletes.

2. POINTS AND SCORING:

2.1. Scoring events:

- a) There will be 5 levels of events included in the ITU World Long Distance Triathlon Points Lists:

- The ITU Long Distance Triathlon World Championships;
- The ITU Long Distance Triathlon World Series events;
- The ITU Long Distance Triathlon Continental Championships;(*)
- The ITU Long Distance Triathlon Continental Cup events;
- The Long Distance Triathlon National Championships. (**)

(*) Athletes from all the continents are eligible to earn points.

(**) Only athletes representing the respective NF will earn points. If the National Federation holds two National Championships, in Long and Middle Distance, the Long Distance Championship will be the one considered.

- b) The points earned by the winner of each event will be:

- 750 for the ITU Long Distance Triathlon World Championships;
- 500 for the ITU Long Distance Triathlon World Series events;
- 500 for the ITU Long Distance Triathlon Continental Championships;
- 250 for the ITU Long Distance Triathlon Continental Cup events;
- 150 for the Long Distance Triathlon National Championships. The points table for each level of event will be from:
 - 1st to 25th for the ITU Long Distance Triathlon World Championships;
 - 1st to 15th for the ITU Long Distance Triathlon World Series events;
 - 1st to 15th for the ITU Long Distance Triathlon Continental Championships;
 - 1st to 10th for the ITU Long Distance Triathlon Continental Cup events;
 - 1st to 5th for the Long Distance Triathlon National Championships.

- c) The points will be decreased by 7.5% every position;

- d) The events included in more than one level (i.e. National Championships taking place in a Continental Cup event) will give only one score to every athlete. If an athlete should gain points by more than one way (i.e. points for the overall event and points for the National Championships) only the highest score will be considered;

- 2.2. **Total Events to Count:** The total number of points acquired by an athlete in a given year will be the result of adding:

- a) the 5 best scores in the previous 53 weeks (current year);

b.) 1/3 of the value of the the **3** best scores gained in the weeks between the 54th and the 106th previous to the date of publication. (previous period).

2.3. **Value of the points depending on the periods:**

- a) The value of the points in the current period will be the same as those gained in the event;
- b) b) The value of the points in the previous period will be 1/3 of those gained in the event.

Appendix E19

ITU Winter Triathlon Points List Criteria

1. PURPOSE:

- 1.1. ITU Long Distance Triathlon Points Lists will be used to determine the best performing Winter triathletes.

2. POINTS AND SCORING:

2.1. Scoring events:

a.) There will be 5 levels of events included in the ITU World Winter Triathlon Points Lists:

- The ITU Winter Triathlon World Championships;
- The ITU Winter Triathlon World Cup events;
- The ITU Winter Triathlon Continental Championships;(*)
- The ITU Winter Triathlon Continental Cup events;
- The Winter Triathlon National Championships. (**)

(*) Athletes from all the continents are eligible to earn points.

(**) Only athletes representing the respective NF will earn points.

b.) The points earned by the winner of each event will be:

- 750 for the ITU Winter Triathlon World Championships;
- 500 for the ITU Winter Triathlon World Cup events;
- 500 for the ITU Winter Triathlon Continental Championships;
- 250 for the ITU Winter Triathlon Continental Cup events;
- 150 for the Long Distance Triathlon National Championships.

c.) The points table for each level of event will be from:

- 1st to 25th for the ITU Winter Triathlon World Championships;
- 1st to 15th for the ITU Winter Triathlon World Cup events;
- 1st to 15th for the ITU Winter Triathlon Continental Championships;
- 1st to 10th for the ITU Winter Triathlon Continental Cup events;
- 1st to 5th for Winter Triathlon National Championships.

d.) The points will be decreased by 7.5% every position;

e.) The events included in more than one level (i.e. National Championships taking place in a Continental Cup event) will give only one score to every athlete. If an athlete should gain points by more than one way (i.e. points for the overall event and points for the National Championships) only the highest score will be considered;

2.2. **Total Events to Count:** The total number of points acquired by an athlete in a given year will be the result of adding:

a) the 3 best scores in the previous 53 weeks (current year);

b.) 1/3 of the value of the the 3 best scores gained in the weeks between the 54th and the 106th previous to the date of publication. (previous period).

2.3. **Value of the points depending on the periods:**

- a.) The value of the points in the current period will be the same as those gained in the event;
- b.) b) The value of the points in the previous period will be $\frac{1}{3}$ of those gained in the event.

Appendix E2o

ITU Paratriathlon Points Lists Criteria

1. GENERAL

- 1.1. ITU Paratriathlon Points Lists will be used to determine the best performing Paratriathletes of the season;
- 1.2. There are 10 ITU Paratriathlon Points Lists, one per Gender and Sport Class: PT1F, PT1M, PT2F, PT2M, PT3F, PT3M, PT4F, PT4M, PT5F and PT5M.

2. POINTS AND SCORING:

2.1. All events scoring events will be sprint distance.

2.2. Scoring events:

- a) There will be 4 levels of events included in the ITU Paratriathlon Points Lists:
 - The ITU Paratriathlon World Championships;
 - The ITU Paratriathlon Continental Championships (*);
 - The ITU sanctioned international Paratriathlon events;
 - The Paratriathlon National Championships (**);
- b) The points earned by the winning athlete for each event, sport class and gender will be:
 - 700 for the ITU Paratriathlon World Championships;
 - 450 for the ITU Paratriathlon Continental Championships (*);
 - 300 for the ITU sanctioned international Paratriathlon events;
 - 150 for the Paratriathlon National Championships (**);
- c) The points table for each level of events will be from:
 - 1st to 30th for the ITU Paratriathlon World Championships;
 - 1st to 25th for the ITU Paratriathlon Continental Championships (*);
 - 1st to 20th for the ITU sanctioned international Paratriathlon events;
 - 1st to 5th for the Paratriathlon National Championships (**);

(*) Limited to the athletes from the respective continent;

(**) Limited to the athletes from the respective nation.
- d) The points will be decreased by 7,5% every position;
- e) The events included in more than one level (i.e. National Championships taking place in an ITU International event) will give only one score to every athlete. If an athlete should gain points by more than one way (i.e. points for the overall event and points for the National Championships), only the highest score will be considered.

2.3. Total events to count:

- a) The total number of points acquired by an athlete at any moment will be the result of adding:
 - The best 3 scores gained in the previous 53 weeks (Current period);
 - 1/3 of the best 3 scores gained in the weeks between the 54th and the 106th previous to the date of publication. (Previous period).

2.4. Value of the points depending on the periods:

- a) The value of the points in the current period will be the same as those gained in the event;

- b) The value of the points in the previous period will be $\frac{1}{3}$ of those gained in the event.
- 2.5. Cut-off: To earn points, athletes must finish within the cut-off time which will be determined by adding 30% to the race winner's time of the respective gender and sport class.

Appendix E21

ITU Continental Ranking Criteria

1. GENERAL:

- 1.1. The Continental Confederations will decide on the existence of the Continental Ranking. The title "ITU Continental Ranking" is generic and the word "ITU" will be replaced by the initials of the respective Continental Confederation.
- 1.2. ITU Continental Rankings will be used to determine the best performing triathletes of the season within the continent;
- 1.3. Pool prize money may be established by the Continental Confederation and will be distributed after the last scoring event according to the ITU Continental Rankings.
- 1.4. The title of the event will have the name of the continent replacing the word, "continent" and the short name of the Continental Confederation, i.e., 2010 Pontevedra ETU Triathlon Premium European Cup.

2. ELIGIBILITY:

- 2.1. Only athletes in good standing with their National Federations affiliated with the Continental Confederation are eligible to be included in the ITU Continental Rankings from their continent.

3. SCORING EVENTS:

- 3.1. The season is determined by the Final event. Events taking place after the Final will be included in the next season.
- 3.2. There will be 5 levels of events included in the ITU Continental Points Lists:
 - a) The ITU Triathlon Continental Championships (standard distance);
 - b) The ITU Triathlon Continental Cup Final events;
 - c) The ITU Triathlon Premium Continental Cup events;
 - d) The ITU Triathlon Continental Cup events;
 - e) **The ITU Triathlon Regional Championships;**
- 3.3. The points earned by the winner of each event will be:
 - a) 600 for the ITU Triathlon Continental Championships (standard distance);
 - b) 500 for the ITU Triathlon Continental Cup Final events;
 - c) 400 for the ITU Triathlon Premium Continental Cup events;
 - d) 250 for the ITU Triathlon Continental Cup events;
 - e) **150 for the ITU Triathlon Regional Championships;**
- 3.4. The points table for each level of event will be from:
 - a) 1st to 40th for the ITU Triathlon Continental Championships (standard distance);
 - b) 1st to 30th for the ITU Continental Cup Final events;
 - c) 1st to 20th for the ITU Triathlon Premium Continental Cup events;
 - d) 1st to 20th for the ITU Triathlon Continental Cup events;
 - e) **1st to 10th for the ITU Triathlon Regional Championships;**

- 3.5. The points will be decreased by 7.5%;
- 3.6. **Cut-off:** To earn points, athletes must finish within the cut-off time which will be determined by adding 5% to the winner's time in the men's event and 8% in the women's event;
- 3.7. **Total Events to Count:** The final score will be obtained by adding the points gained in the ITU Continental Cup Final plus the 4 best scores obtained in the rest of scoring events of the season.

27. APPENDICES F UNIFORM RULES

APPENDIX F1:

ELITE, UNDER23, JUNIOR AND YOUTH UNIFORM RULES

1. Overview:

- 1.1. To compete in ITU events, athletes must comply with the ITU Uniform Rules and the reference to the Uniform at 2.8 of the Competition Rules;
- 1.2. The images on this document are reproducing a typical triathlon uniform. For winter triathlon and, in some cases, in triathlon, duathlon and aquathlon, the long sleeves and lower leg covering are allowed. This appendix applies in the same way for all the cases;

2. Purpose:

- 2.1. Provide a clean and professional image of our sport to local and global spectators and media;
- 2.2. Provide sponsors with reasonable space for viable exposure;
- 2.3. Provide a framework for enabling ITU member National Federations (NFs) and athletes to have a mutually beneficial relationship with respect to rights and responsibilities, as per Appendix F.2.

3. General Requirements:

- 3.1. Uniforms will be completely clean of any logos or images other than those described below;
- 3.2. Logos will be measured on a flat surface when the athlete is not wearing the uniform. The "ITU Logo Measurement Template" will be used to measure the logo sizes;
- 3.3. There is no restriction on the type of logo used in the sponsor spaces other than those representing tobacco, spirits and products containing any substance on the WADA Prohibited List;
- 3.4. There must be a minimum clearance space of 1.5cm around all marks including:
 - a) The ITU logo;
 - b) The family name;
 - c) The country code;
 - d) All sponsor logos.

4. Uniform Colour and Design:

- 4.1. Uniforms must be in the colours chosen by the National Federation (NF) for ITU World Triathlon Series Grand Final, ITU World Triathlon Series, ITU Continental Championships and ITU Multisport World Championships events. For all other ITU events the uniform colors have no restrictions;
- 4.2. The colour and design of the uniform and podium apparel must be distinct to that country and must be approved by ITU in advance;
- 4.3. Country uniforms must have a distinct look, however the design requirements should not impact on technical requirements athletes might have due to body shape or size;

- 4.4. The approval process for the uniform colour and design is outlined in Appendix F7. The goal of the approval process is to ensure countries do not have the same uniform colour and design;
- 4.5. ITU reserves the right to establish a specific rule till 30th of January regarding the color of the uniform of the actual leader of ITU World Triathlon Series has to wear:

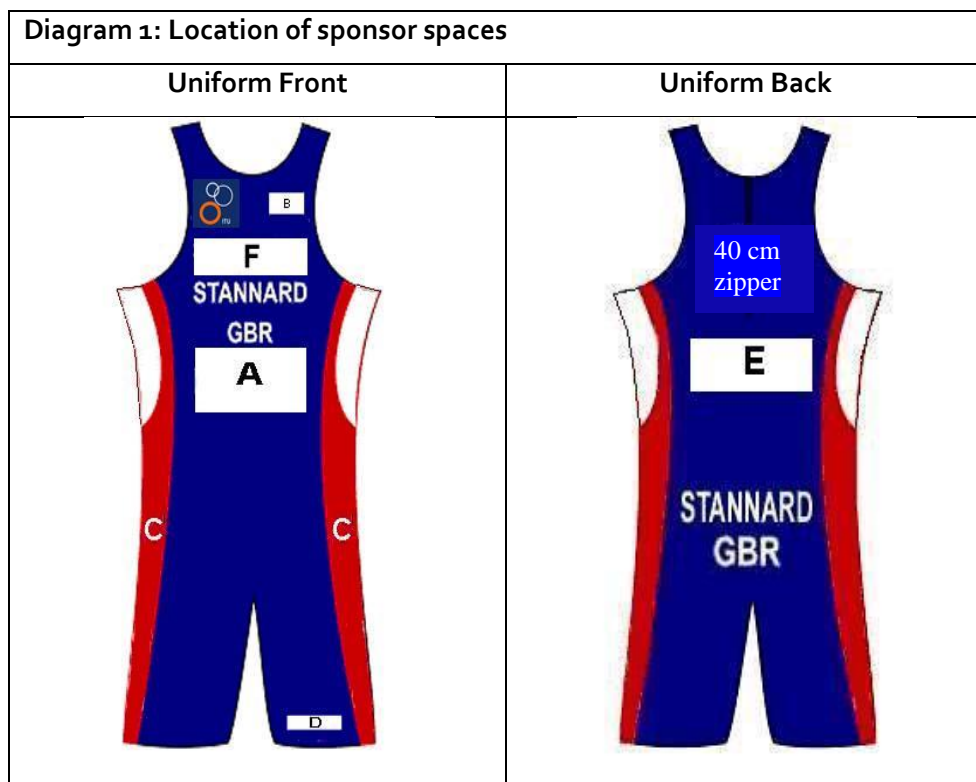

5. Family Name and Country Code/Name:

- 5.1. The family name and the IOC country code must be placed on the upper front of the uniform and also on the buttocks. The initial of the first name may be added before the family name: athletes with the same family name are encouraged to add the initial of the first name. The representation of both the family name and country code must meet the following criteria:
- Font Type:**
 - The font type must be "Arial";
 - Letters for the family name and country code must be in upper case, unless the name is more than 9 letters, in which case lower case letters should be used following the first capital letter. Symbols such as ` - . and space are considered as characters (See Diagram 2: Family Name Layout).
 - Colour:**
 - If the uniform is a dark colour, the letters must be white. If the uniform is a light colour, the letters must be black.
 - Position:**
 - Front: The position on the front is below the ITU logo and Sponsor Spaces B and F. The athlete's family name is above the country code and Sponsor Space A;
 - Back: The position on the back is below the waistline so that it is clearly visible when the athlete is on the bike. The athlete's family name is above the country code;

- Height: The family name and the country code must be 5cm in height, regardless of the number of letters in the name;
- Width: The length for the family name is a minimum of 12cm and a maximum of 15cm. A family name with few letters must still be a minimum length of 12 cm. (See Diagram 2: Family Name Layout) The width for the country code must be 6cm to 10 cm;

Diagram 2. Family Name Layout

MAY

- For family names such as "MAY" above, the height is 5cm and the width is 12cm.
- For longer names such as "Polikarpenko" below, the height is still a minimum 5cm but the name should take up the full 15cm.

Polikarpenko

6. ITU Logo:

- 6.1. The official ITU logo will appear on the upper **right** shoulder;
- 6.2. It will conform to the official ITU rings with the letters ITU on the bottom right;
- 6.3. The horizontal dimension will be 4cm;
- 6.4. The white version should be applied to dark coloured uniforms, the blue and orange version should be applied to light coloured uniforms (see 6.5, 6.6, Diagram 3);

6.5. Click [here](#) for the print version of the ITU logo:

Diagram 3. ITU Logo Layout

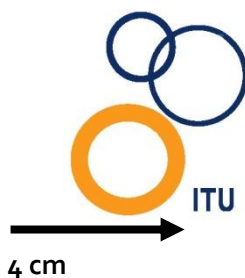

6.6. Diagram 3 above shows the correct layout for the ITU Logo:

- a) ITU Orange:
 - Pantone 144C (Coated papers);
 - CMYK conversion (four-colour process) - C: 0%, M: 49%, Y: 100%, K: 0%.
- b) ITU Blue:
 - Pantone 2955C (Coated papers);
 - CMYK conversion (four-colour process) - C: 100%, M: 45%, Y: 0%, K: 37%.

6.7. Individual World Champions are allowed to add below the ITU Logo the design element of the WTS recognizing this honor. Graphic details will be published separately.

7. Sponsor Spaces:

7.1. Sponsor Space A:

- a) This space is directly below the country code (See Diagram 1. Sponsor Logos: size and space);
- b) The maximum height is 20cm;
- c) The maximum length is 15cm;
- d) Up to 3 sponsor logos may be positioned in this space;
- e) The athlete may have 1, 2 or 3 logos in this space. Each of the logos must represent a different sponsor.

7.2. Sponsor Space B: upper left front:

- a) This space is for the manufacturer of the uniform or for another sponsor;
- b) The maximum height is 4cm;
- c) The maximum length is 5cm;
- d) The space must be on the left hand shoulder of the uniform – not the middle.

7.3. Sponsor Spaces C: side panels:

- a) Sponsor logos may appear on the side panel;
- b) The maximum width is 5cm;
- c) The maximum length is 15cm;
- d) Only one sponsor logo is allowed on each side and it must be the same sponsor logo;
- e) This space must be visible from the side of the body. If, due to the athlete body, this space is partly visible from the front, it has to be visible also from the back;

- 7.4. **Sponsor Space D: lower front:**
- a) The maximum height is 4cm;
 - b) The maximum length is 5cm;
 - c) This space can be on the lower left or right side of the uniform but not both.
- 7.5. **Sponsor Space E: upper back:**
- a) One logo of any sponsor may appear above the family name on the back;
 - b) The maximum height is 10cm;
 - c) The maximum length is 15cm;
- 7.6. **Sponsor Space F: upper front:**
- a) One logo of any sponsor may appear above the family name on the front;
 - b) The maximum height is 5cm;
 - c) The maximum length is 15cm.

8. Headwear:

8.1. Swim:

- a) No sponsor logos are allowed on the swim cap other than as prescribed by ITU/LOC.

8.2. Cycle:

- a) Athletes must wear helmets on the bicycle segment, as described by the ITU Competition Rules;
- b) Helmet race number stickers, provided by ITU or the LOC, must be placed on the front and both sides of the helmet, without any alteration. No other stickers are allowed;
- c) There must be a clearance around the official helmet number sticker of 1.5cm to ensure the number is clearly visible;
- d) The helmet can be any colour or design and include any logo provided it meets the requirements in b) & c) above.

8.3. Run:

- a) Athletes may wear hats or visors on the run section;
- b) Only 1 sponsor logo can be placed on the hat or visor;
- c) The maximum height is 4cm;
- d) The maximum total area is 20cm².

9. Bicycle:

- a) Only logos of bicycle related products may appear on the athlete's bicycle;
- b) Logos may not interfere with, or hinder the placement of, the bicycle race number on the bicycle frame;
- c) Bike race number stickers, provided by ITU or the LOC, must be placed on the bike as instructed, without any alteration.

10. Wetsuits:

10.1. Logos:

- a) Only the wetsuit manufacturer's logo may appear on the wetsuits;
- b) The maximum size is 80cm² on the front and back. This space is allowed both on the inside and outside of the wetsuit;
- c) If the manufacturer wishes to have two or more logos on the front or back, the combined total must not exceed 80cm²;
- d) Logos on the side panel must be included within either the 80cm² for the back or the 80cm² for the front.

11. Body Decals:

- 11.1. ITU will provide body number decals, which may include a race identification logo, and each elite athlete will apply them prior to the event.
- 11.2. One set of body number decals are to be applied to each arm and each leg;
- 11.3. For double digit numbers, decals must be applied one above the other, not side by side;

For example the number 23 should appear like this $\begin{matrix} 2 \\ 3 \end{matrix}$ Not like this... **23**

12. Temporary Tattoos:

- 12.1. Athletes are not allowed to place any temporary tattoo, other than the race numbers and logos provided by ITU, on their body during ITU events.

13. Podium apparel.

- 13.1. All the sponsor spaces and design colors indicated in this appendix, apply as well to the podium apparel.

APPENDIX F2: RIGHTS AND RESPONSIBILITIES (Elite, U23, Junior and Youth athletes)

	World Triathlon Series and Grand Final	Triathlon World Cup	Continental Championships	Triathlon Continental Cup	Multisport Championships	Other ITU Events
Uniform Colour and Design	As per the catalog	To be agreed in good faith between Athlete and NF	As per the catalog	To be agreed in good faith between Athlete and NF	As per the catalog	To be agreed in good faith between Athlete and NF
Family Name	Mandatory as per ITU Competition Rules					
Country Code						
ITU Logo						
Sponsor Spaces A to F	To be agreed in good faith between Athlete and NF					

APPENDIX F₃: PARATRIATHLON UNIFORM RULES

1. Overview:

- 1.1. To compete in ITU events, athletes must comply with the ITU Uniform Rules and the reference to the Uniform at 2.8 of the Competition Rules;
- 1.2. The images in this document are reproducing a typical triathlon uniform. For winter triathlon, and, in some cases, in triathlon, duathlon and aquathlon, long sleeves and lower leg covering are allowed. This appendix applies in the same way in all cases.

2. Purpose:

- 2.1. Provide a clean and professional image of our sport to local and global spectators and media;
- 2.2. Provide sponsors with reasonable space for viable exposure;
- 2.3. Provide a framework for ITU member National Federations (NFs) and athletes to enable both parties to have a mutually beneficial relationship with respect to rights and responsibilities, as per Appendix F.4.

3. General Requirements:

- 3.1. Uniforms will be completely clean of any logos or images other than those described below;
- 3.2. Logos will be measured on a flat surface when the athlete is not wearing the uniform. The "ITU Logo Measurement Template" will be used to measure the logo sizes;
- 3.3. There is no restriction on the type of logo used in the sponsor spaces other than those representing tobacco, spirits and products containing any substance on the WADA Prohibited List. (See Diagram 1 for location of sponsor spaces);
- 3.4. There must be a minimum clearance space of 1.5cm around all marks including:
 - a) The ITU logo;
 - b) The family name;
 - c) The country code;
 - d) All sponsor spaces.

4. Uniform Colour and Design:

- 4.1. Uniforms must be in the colours chosen by the National Federation (NF) for ITU World Championship Grand Final, ITU Continental Championships and ITU Multisport World Championships events;
- 4.2. The colour and design of the uniform and podium apparel must be distinct to that country and must be approved by ITU in advance;
- 4.3. It is intended to give the country uniforms a distinct look. However the design definition should not impact on technical requirements that athletes might have due to body shape or size;
- 4.4. The approval process for the uniform colour and design is outlined in Appendix F7. The goal of the approval process is to ensure different countries do not have the same uniform colour and design.

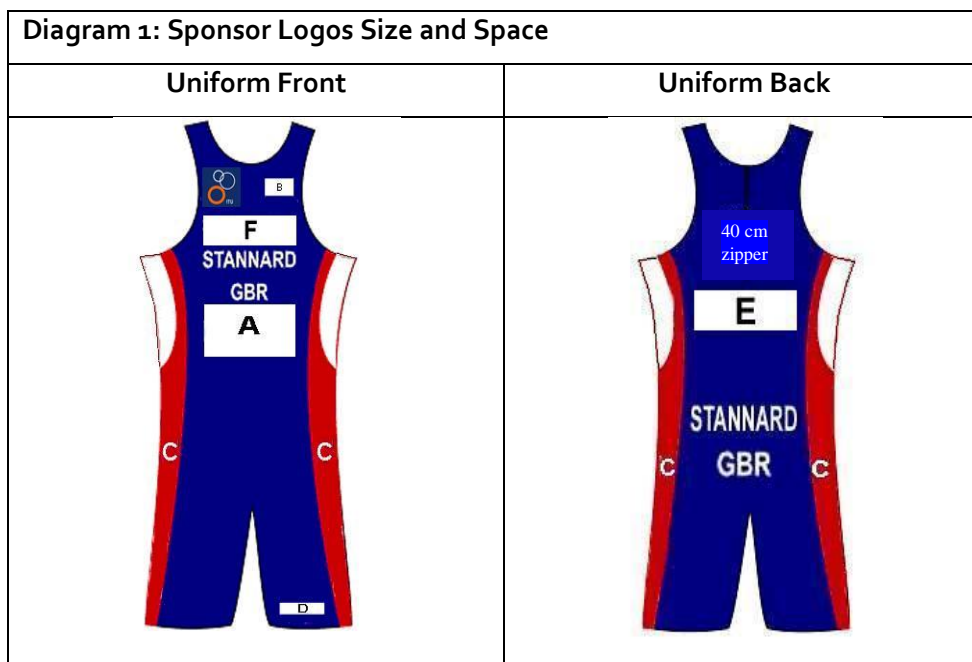

5. Family Name and Country Code:

5.1. **The family name** and the IOC country code must be placed on the upper front of the uniform and also on the buttocks. The initial of the first name may be added before the family name: athletes with the same family name are encouraged to add the initial of the first name. The representation of both the family name and country code must meet the following criteria:

a) Font Type:

- The font type must be "Arial";
- Letters for the family name and country code must be in upper case, unless the name is more than 9 letters, in which case lower case letters should be used following the first capital letter. Symbols such as ' - . and space are considered as characters (See Diagram 2: Family Name Layout).

b) Colour:

- If the uniform is a dark colour, the letters must be white. If the uniform is a light colour, the letters must be black.

c) Position:

- Front: The position on the front is below the ITU logo and Sponsor Spaces B and F. The athlete's family name is above the country code and Sponsor Space A;
- Back: The position on the back is below the waistline so that it is clearly visible when the athlete is on the bike. The athlete's family name is above the country code;
- Height: The family name and the country code must be 5cm in height, regardless of the number of letters in the name;
- Width: The length for the family name is a minimum of 12cm and a maximum of 15cm. A family name with few letters must still be a minimum length of 12 cm. (See Diagram 2: Family Name Layout) The width for the country code must be 6cm to 10 cm;

Diagram 2. Family Name Layout

MAY

- For family names such as "MAY" above, the height is 5cm and the width is 12cm.
- For longer names such as "Polikarpenko" below, the height is still a minimum 5cm but the name should take up the full 15cm.

Polikarpenko

6. ITU Logo:

- 6.1. The official ITU logo will appear on the upper **right** shoulder;
- 6.2. It will conform to the official ITU rings with the letters ITU on the bottom right;
- 6.3. The horizontal dimension will be 4cm;
- 6.4. The white version should be applied to dark coloured uniforms, the blue and orange version should be applied to light coloured uniforms (see 6.5, 6.6, Diagram 3);
- 6.5. Click [here](#) for the print version of the ITU logo;

Diagram 3. ITU Logo Layout

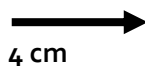

6.6. Diagram 3 above shows the correct layout for the ITU Logo:

- a) ITU Orange:
 - Pantone 144C (Coated papers);
 - CMYK conversion (four-colour process) - C: 0%, M: 49%, Y: 100%, K: 0%.
- b) ITU Blue:
 - Pantone 2955C (Coated papers);
 - CMYK conversion (four-colour process) - C: 100%, M: 45%, Y: 0%, K: 37%.

7. Sponsor Spaces:

7.1. Sponsor Space A:

- a) This space is directly below the country code (See Diagram 1. Sponsor Logos: size and space);
- b) The maximum height is 20cm;
- c) The maximum length is 15cm;
- d) Up to 3 sponsor logos may be positioned in this space;
- e) The athlete may have 1, 2 or 3 logos in this space. Each of the logos must represent a different sponsor.

7.2. Sponsor Space B: upper left front:

- a) This space is for the manufacturer of the uniform or for another sponsor;
- b) The maximum height is 4cm;
- c) The maximum length is 5cm;
- d) The space must be on the left hand shoulder of the uniform – not the middle.

7.3. Sponsor Spaces C: side panels:

- a) Sponsor logos may appear on the side panel;
- b) The maximum width is 5cm;
- c) The maximum length is 15cm;
- d) Only one sponsor logo is allowed on each side and it must be the same sponsor logo;
- e) This space must be visible from the side of the body. If, due to the athlete body, this space is partly visible from the front, it has to be visible also from the back.

7.4. Sponsor Space D: lower front:

- a) The maximum height is 4cm;
- b) The maximum length is 5cm;
- c) This space can be on the lower left or right side of the uniform but not both.

7.5. Sponsor Space E: upper back:

- a) One logo of any sponsor may appear above the family name on the back;
- b) The maximum height is 10cm;
- c) The maximum length is 15cm.

7.6. Sponsor Space F: upper front:

- a) One logo of any sponsor may appear above the family name on the front;
- b) The maximum height is 5cm;
- c) The maximum length is 15cm.

8. Headwear:

8.1. Swim:

- a) No sponsor logos are allowed on the swim cap other than as prescribed by the ITU / LOC.

8.2. Cycle:

- a) Athletes must wear helmets on the bicycle section, as described by the ITU Competition Rules;
- b) Helmet race number stickers, provided by ITU or the LOC, must be placed on the front and both sides of the helmet, without any alteration. No other stickers are allowed;
- c) There must be a clearance around the official helmet number sticker of 1.5cm to ensure the number is clearly visible;
- d) The helmet can be any colour or design and include any logo provided it meets the requirements in b) & c) above.

8.3. Run:

- a) Athletes may wear hats or visors on the run section;
- b) Only 1 sponsor logo can be placed on the hat or visor;
- c) The maximum height is 4cm;
- d) The maximum total area is 20cm².

9. Bicycle:

- a) Only logos of bicycle related products may appear on the athlete's bicycle;
- b) Logos may not interfere with, or hinder the placement of, the bicycle race number on the bicycle frame;
- c) Bike race number stickers, provided by ITU or the LOC, must be placed on the bike as instructed, without any alteration.

10. Wetsuits:

10.1. Logos:

- a) Only the wetsuit manufacturer's logo may appear on the wetsuits;
- b) The maximum size is 80cm² on the front and back. This space is allowed both on the inside and outside of the wetsuit;
- c) If the manufacturer wishes to have two or more logos on the front or back, the combined total must not exceed 80cm²;
- d) Logos on the side panel must be included within either the 80cm² for the back or the 80cm² for the front.

11. Race Numbers:

11.1. **Traditional race numbers:** Race numbers, provided by ITU or the LOC, must be worn as instructed by the ITU Technical Delegate on the Athletes' or Team Managers' Briefing, without any alteration;

11.2. Body Marking:

- a) LOC will provide body marking and each elite athlete will apply them prior to the event;
- b) One set of body marking is to be applied to each arm and each leg unless instructed by the ITU Technical Delegate on the Athletes' or Team Managers' Briefing.

12. Temporary Tattoos:

12.1. Athletes are not allowed to place any temporary tattoo.

13. Specific Rules for PT5 Sport Class:

13.1. The uniform of the Guide must comply with the rules above and use the same sponsors' logos and spaces as on the Paratriathlete's uniform;

13.2. At the Family Name space, the uniform of the Guide must have the word "GUIDE";

13.3. The font type must be "Arial", the height 5cm and the width 12 cm.

APPENDIX F₄: RIGHTS AND RESPONSIBILITIES (Paratriathlon athletes)

	Triathlon World Championships and Continental Championships	Multisport Championships	Other ITU Events
Uniform Colour and Design	As per the catalog	As per the catalog	To be agreed in good faith between Athlete and NF
Family Name	Mandatory as per ITU Competition Rules		
Country Code			
ITU Logo			
Sponsor Spaces A to F	To be agreed in good faith between Athlete and NF		

APPENDIX F5: AGE GROUP UNIFORM RULES

1. Overview:

- 1.1. To compete in ITU events, athletes must comply with the ITU Uniform Rules and the reference to the Uniform at 2.8 of the Competition Rules;
- 1.2. The images in this document are reproducing a typical triathlon uniform. For winter triathlon, and in some cases in triathlon, duathlon and aquathlon, long sleeves and lower leg covering are allowed. This appendix applies in the same way in all cases.

2. Purpose:

- 2.1. Provide a clean and professional image of our sport to local and global spectators and media;
- 2.2. Provide sponsors with reasonable space for viable exposure;
- 2.3. Provide a framework enabling ITU member National Federations (NFs) and athletes to have a mutually beneficial relationship with respect to rights and responsibilities, as per Appendix F.6.

3. General Requirements:

- 3.1. Uniforms will be completely clean of any logos or images other than those described below;
- 3.2. Logos will be measured on a flat surface when the athlete is not wearing the uniform. The "ITU Logo Measurement Template" will be used to measure the logo sizes;
- 3.3. There is no restriction on the type of logo used in the sponsor spaces other than those representing tobacco, spirits and products containing any substance on the WADA Prohibited List. (See Diagram 1 for location of sponsor spaces);
- 3.4. There must be a minimum clearance space of 1.5cm around all marks including:
 - a) The ITU logo;
 - b) The family name;
 - c) The country code;
 - d) All sponsor spaces.

4. Uniform Colour and Design:

- 4.1. Uniforms must be in the colours chosen by the National Federation (NF) for ITU World Championship, ITU Continental Championships and ITU Multisport World Championships events;
- 4.2. The colour and design of the uniform and podium apparel must be distinct to that country and must be approved by ITU in advance;
- 4.3. Country uniforms must have a distinct look, however the design requirements should not impact on technical requirements athletes might have due to body shape or size;
- 4.4. The approval process for the uniform colour and design is outlined in Appendix F7. The goal of the approval process is to ensure different countries do not have the same uniform colour and design:

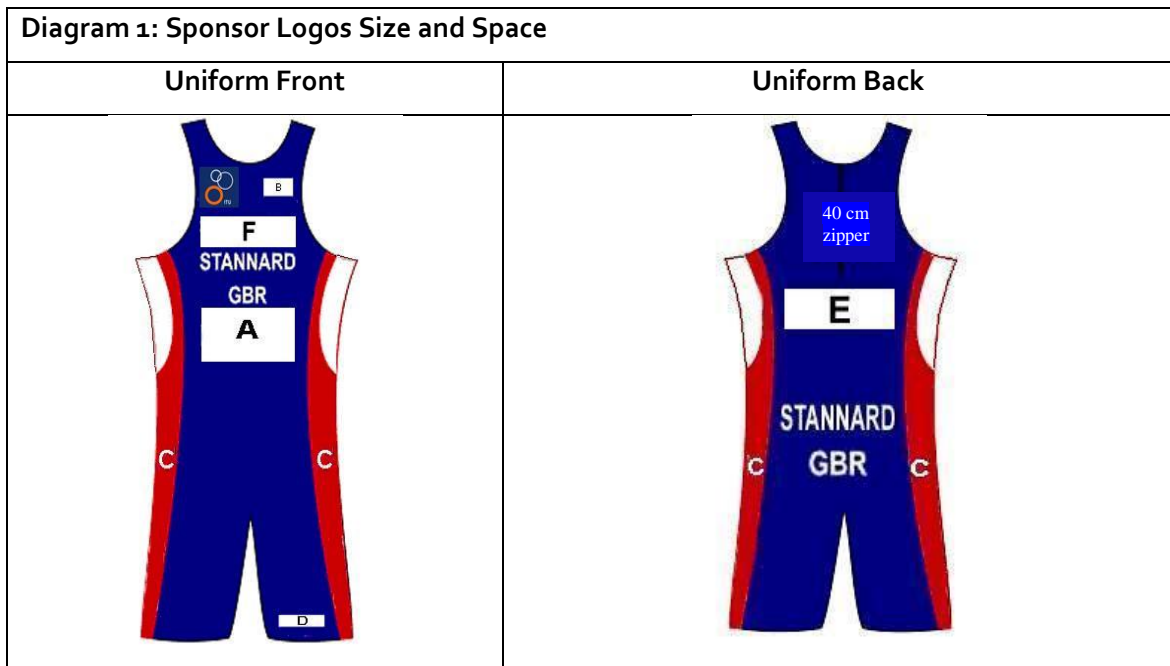

5. Family Name and Country Code:

5.1. The IOC country code must be placed on the upper front of the uniform and also on the buttocks. The placement of the family name on the upper front and on the buttock of the uniform is optional for Age Group athletes. The initial of the first name may be added before the family name: athletes with the same family name are encouraged to add the initial of the first name. The representation of both the family name and country code must meet the following criteria:

a) Font Type:

- The font type must be "Arial";
- Letters for the family name and country code must be in upper case, unless the name is more than 9 letters, in which case lower case letters should be used following the first capital letter. Symbols such as ` - . and space are considered as characters (See Diagram 2: Family Name Layout).

b) Colour:

- If the uniform is a dark colour, the letters must be white. If the uniform is a light colour, the letters must be black.

c) Position:

- Front: The position on the front is below the ITU logo and Sponsor Spaces B and F. The athlete's family name is above the country code and Sponsor Space A;
- Back: The position on the back is below the waistline so that it is clearly visible when the athlete is on the bike. The athlete's family name is above the country code;
- Height: The family name and the country code must be 5cm in height, regardless of the number of letters in the name;
- Width: The length for the family name is a minimum of 12cm and a maximum of 15cm. A family name with few letters must still be a minimum length of 12 cm. (See Diagram 2: Family Name Layout) The width for the country code must be 6cm to 10 cm:

Diagram 2. Family Name Layout

MAY

- For family names such as "MAY" above, the height is 5cm and the width is 12cm.
- For longer names such as "Polikarpenko" below, the height is still a minimum 5cm but the name should take up the full 15cm.

Polikarpenko

6. ITU Logo:

- 6.1. The official ITU logo will appear on the upper **right** shoulder;
- 6.2. It will conform to the official ITU rings with the letters ITU on the bottom right;
- 6.3. The horizontal dimension will be 4cm;
- 6.4. The white version should be applied to dark coloured uniforms, the blue and orange version should be applied to light coloured uniforms (see 6.5, 6.6, Diagram 3);
- 6.5. Click [here](#) for the print version of the ITU logo:

Diagram 3. ITU Logo Layout



- 6.6. Diagram 3 above shows the correct layout for the ITU Logo:
- a) ITU Orange:
 - Pantone 144C (Coated papers);
 - CMYK conversion (four-colour process) - C: 0%, M: 49%, Y: 100%, K: 0%.
 - b) ITU Blue:
 - Pantone 2955C (Coated papers);
 - CMYK conversion (four-colour process) - C: 100%, M: 45%, Y: 0%, K: 37%.

7. Sponsor Spaces:

7.1. Sponsor Space A:

- a) This space is directly below the country code (See Diagram 1. Sponsor Logos: size and space);
- b) The maximum height is 20cm;
- c) The maximum length is 15cm;
- d) Up to 3 sponsor logos may be positioned in this space;
- e) The athlete may have 1, 2 or 3 logos in this space. Each of the logos must represent a different sponsor.

7.2. Sponsor Space B: upper left front:

- a) This space is for the manufacturer of the uniform or for another sponsor;
- b) The maximum height is 4cm;
- c) The maximum length is 5cm;
- d) The space must be on the left hand shoulder of the uniform – not the middle.

7.3. Sponsor Spaces C: side panels:

- a) Sponsor logos may appear on the side panel;
- b) The maximum width is 5cm;
- c) The maximum length 15cm;
- d) Only one sponsor logo is allowed on each side and it must be the same sponsor logo;
- e) This space must be visible from the side of the body. If, due to the athlete body, this space is partly visible from the front, it has to be visible also from the back.

7.4. Sponsor Space D: lower front:

- a) The maximum height is 4cm;
- b) The maximum length is 5cm;
- c) This space can be on the lower left or right side of the uniform but not both.

7.5. Sponsor Space E: upper back:

- a) One logo of any sponsor may appear above the family name on the back;
- b) The maximum height is 10cm;
- c) The maximum length is 15cm.

7.6. Sponsor Space F: upper front:

- a) One logo of any sponsor may appear above family name and/or the country code on the front;
- b) The maximum height is 5cm;
- c) The maximum length is 15cm.

8. Headwear:

8.1. Swim:

- a) No sponsor logos are allowed on the swim cap other than as prescribed by the ITU / LOC.

8.2. Cycle:

- a) Athletes must wear helmets on the bicycle section, as described by the ITU Competition Rules;
- b) Helmet race number stickers, provided by ITU or the LOC, must be placed on the front and both sides of the helmet, without any alteration. No other stickers are allowed;
- c) There must be a clearance around the official helmet number sticker of 1.5cm to ensure the number is clearly visible;
- d) The helmet can be any colour or design and include any logo provided it meets the requirements in b) & c) above.

8.3. Run:

- a) Athletes may wear hats or visors on the run section;
- b) Only 1 sponsor logo can be placed on the hat or visor;
- c) The maximum height is 4cm;
- a) The maximum total area is 20cm².

9. Bicycle:

- a) Only logos of bicycle related products may appear on the athlete's bicycle;
- b) Logos may not interfere with, or hinder the placement of, the bicycle race number on the bicycle frame;
- c) Bike race number stickers, provided by ITU or the LOC, must be placed on the bike as instructed, without any alteration.

10. Wetsuits:

10.1. Logos:

- a) Only the wetsuit manufacturer's logo may appear on the wetsuits;
- b) The maximum size is 80cm² on the front and back. This space is allowed both on the inside and outside of the wetsuit;
- c) If the manufacturer wishes to have two or more logos on the front or back, the combined total must not exceed 80cm²;
- d) Logos on the side panel must be included within either the 80cm² for the back or the 80cm² for the front.

11. Race Numbers:

11.1. **Traditional race numbers:** Race numbers, provided by ITU or the LOC, must be worn as instructed by the ITU Technical Delegate on the Athletes' or Team Managers' Briefing, without any alteration.

11.2. Body Marking:

- a) Athletes will be marked on each arm and each leg unless otherwise instructed by the ITU Technical Delegate at Athletes' or Team Managers' Briefing;
- b) One calf of the athletes must be marked with the category and the gender of the athletes. (For example the number M25 should appear for men athletes in the category men 25-29 or the number F40 should appear for the women athletes in category women 40-44.).

12. Temporary Tattoos:

12.1. Athletes are not allowed to place any temporary tattoo.

APPENDIX F6: RIGHTS AND RESPONSIBILITIES (Age Group athletes)

	Triathlon World Championships and Continental Championships	Multisport Championships	Other ITU Events
Uniform Colour and Design	As per the catalog	To be agreed in good faith between Athlete and NF	To be agreed in good faith between Athlete and NF
Family Name	Optional as per ITU Competition Rules		
Country Code	Mandatory as per ITU Competition Rules		
ITU Logo			
Sponsor Spaces A to F	To be agreed in good faith between Athlete and NF		

APPENDIX F7: ITU COMPETITION UNIFORM APPROVAL PROCESS

1. Overview:

- 1.1 This process is part of the ITU Uniform Rules and is a specific addition to the ITU Competition Rules.

2. Purpose:

- 2.1 The process was created to regulate the ITU's approval of the design of each NF's competition uniform to be used by their athletes in all ITU competitions according with the ITU Uniform Rules.

3. General Requirements:

- 3.1 Every NF uniform has to be different from any other NF uniform, according to the ITU Uniform Rules. The difference will be significant to avoid confusion between two different NFs;
- 3.2 Artistic or creative elements are acceptable provided that the ITU Competition Rules are followed. Specifically, if the design contains recognisable commercial logos or trade marks which exceed the surface limits, it will not be approved;
- 3.3 The same design applies to all types of uniforms: men, women, triathlon style, duathlon style, summer, winter, etc;
- 3.4 Every NF can request the approval of one different uniform design for every different multisport. Two uniform options can be requested for the Age Group athletes, indicating which is the 1st option and which is the 2nd option. However, all athletes from the same NF, competing in the same event, will wear the NF's same distinctive design.

4. Timeline for Approval:

- 4.1 NFs will submit a proposed design of their Competition Uniform for the following year, according to these specifications:
 - a) A pattern provided by ITU will be used, (see Diagram 1, ITU Competition Rules.);
 - b) Sponsor spaces and dimensions, as outlined the ITU Uniform Rules. The athlete's family name and NF code positions (front and back) and dimensions of both;
 - c) The position and dimensions of the ITU logo. The colour(s) used in the design, including the pantone. The proposed design may be submitted in .jpg .gif .bmp or .tif format.
- 4.2 Once approved, the Uniform approval is extended till the the NF must seek approval for a new design.

5. Approval:

- 5.1 ITU will inform each NF in writing about the approval or disapproval of their NFs uniform if the design is:
 - a) Compliant with all the ITU Uniform Rules;
 - b) Distinct from other NF designs.
- 5.2 If the request is not approved ITU will:
 - a) Ask the NF for a new design if the submitted one did not comply with the ITU rules, or;
 - b) Ask the NFs that submitted similar requests to agree to modifying their proposed designs in order to have different uniforms;

- c) If the NFs do not get an agreement ITU will decide on which NF can use the proposed design according with these priorities:
 - The NF that used the proposed uniform in the past will be given preference;
 - If both NFs are proposing new uniforms, a draw will be conducted to choose which NF will use the submitted design and which NF(s) will have to submit a new one.
- 5.3 ITU will produce an electronic catalogue of approved NF's competition uniforms. This catalogue will be updated monthly;
- 5.4 Requests for uniform approval received will be considered on a monthly basis. NFs requesting approval will choose designs that are different from those already approved.

6. Approval Panel:

- 6.1 All decisions on uniform approval will be made by a panel composed of:
 - a) A member of the ITU Technical Committee;
 - b) A representative of the ITU Sport Department;
 - c) A member of the ITU World Triathlon Series Commission;
 - d) A representative of the ITU Media and Television Department;
 - e) A representative of the ITU Coaches Committee.
- 6.2 The decisions of the Approval Panel can be appealed to the **ITU Arbitration Tribunal**. This appeal does not suspend the decision of the Approval Panel, but rather the decision will stay in place during the time the **ITU Arbitration Tribunal** takes to make a decision on the appeal.

28. APPENDIX G: PARATRIATHLON CLASSIFICATION:

1. General:

1.1 Scope and Application:

- a) These rules and regulations are an integral part of the ITU Competition Rules and are intended to implement the provisions of the IPC Classification Code for the sport of Paratriathlon.
- b) These Rules and Regulations shall apply to:
 - (i) All athletes and athlete support personnel, who are registered with ITU, as defined in the ITU Competition Rules;
 - (ii) All athletes and athlete support personnel participating in such capacity in ITU events and competitions recognized by ITU or any of its members or affiliate organisations or licensees.
- c) It is the personal responsibility of athletes, athlete support personnel and classification personnel to acquaint themselves with all of the requirements of these rules and regulations, the IPC Classification Code - IPC Handbook, Section 2, Chapter 1.3 – and the other sections of the IPC Handbook that apply to classification, including the IPC Position Statement on Background and Scientific Rationale for Classification in Paralympic Sport (see IPC Handbook, Section 2, Chapter 4.4). (<http://www.paralympic.org/the-ipc/handbook>)

1.2 Definition and Purpose:

- a) These Classification Rules and Regulations provide a framework within which the process of “Classification” will take place. The term “Classification” refers to a structure for competition, the aim of which is to ensure that an athlete’s impairment is relevant to sport performance, and to ensure that athletes compete equitably with each other. The purpose of classification is to minimize the impact of eligible impairment types on the outcome of competition, so that athletes who succeed in competition are those with best anthropometry, physiology and psychology, and who have enhanced them to best effect.

1.3 International Classification:

- a) Athlete evaluation that is conducted in full compliance with these rules and regulations at ITU events is referred to as international classification. ITU will only recognize Sport Class and Sport Class Status if allocated by way of international classification;
- b) ITU will provide athletes with an opportunity to undertake international classification by appointing classifiers certified pursuant to conduct athlete evaluation at ITU events, and by providing reasonable notice of such international classification opportunities to athletes and National Federations;
- c) International classification will determine eligibility to compete by type of impairment and severity of impairment;
- d) An athlete will only be permitted to undergo international classification if he or she:
 - (i) is registered according to ITU Competition Rules, and;
 - (ii) has been entered in an ITU event or competition recognized by ITU where international classification is taking place or has entered a recognized classification opportunity by ITU.

1.4 International Paralympic Committee (IPC) Code:

- a) The ITU Paratriathlon Classification Rules and Regulations comply with the IPC Code, which sets **policies and procedures and international standards for operational guidelines** across all Paralympic sports;
- b) ITU Constitution and ITU Competition Rules are compliant with the IPC Code of Ethics; (<http://www.paralympic.org/the-ipc/handbook>)
- c) ITU is committed to developing an evidence-based classification system through coordinated research, according to the IPC Code and research practices;
- d) Classification research is multi-disciplinary, including biomechanics, kinesiology and physiology, where appropriate;
- e) IPC is playing a major role in the review and application of classification research and the coordination of any research conducted in the associated disciplines.

1.5 Classification Master List

- a) ITU shall maintain a Classification Master List, which shall include at the very least each internationally classified athlete's name, year of birth, country, sport class, sport class status.
- b) **The ITU Classification Master List will be available on the ITU website under http://www.triathlon.org/about/downloads_category/paratriathlon**

Classification Personnel: ITU shall appoint the following classification personnel, each of whom will have a key role in administration, organisation and execution of classification

2.1 Head of Classification:

- a) The Head of Classification (HoC) is a classifier who together with the Sport Department, is responsible for the direction, administration, co-ordination and implementation of classification matters for ITU;
- b) The Head of Classification is appointed by the ITU Executive Board from the proposal made by the Paratriathlon Committee following the quadrennial elections;
- c) The Head of Classification and **ITU Sport Department** also delegate tasks to specific senior classifiers or appointed persons to assist with the specific responsibilities of the HoC.

2.2 Deputy Head of Classification:

- a) The Deputy Head of Classification (DHoC) is a classifier who can when required assume the roles and responsibilities of the HoC including taking responsibility for ITU Sports Department related matters;
- b) The Deputy Head of Classification is appointed by the ITU Executive Board from the proposal made by the Paratriathlon Committee following the quadrennial elections.

2.3 Classifier:

- a) An individual authorised as a Technical Official by ITU to determine an athlete's sports class and sports class status, while serving as a member of a classification panel, in accordance with the ITU Competition Rules;
- b) An ITU International Paratriathlon Classifier must be trained and certified by ITU or by International Blind Sports Association (IBSA) or the IPC.

2.4 Chief Classifier:

- a) The Chief Classifier is a classifier responsible for the direction, administration, co-ordination and implementation of classification matters for a specific competition;
- b) The Head of Classification in conjunction with the Sport Department is responsible for appointing the Chief Classifier for ITU events;
- c) The Chief Classifier supervises classifiers to ensure that the classification rules and regulations are applied appropriately during a specific competition;
- d) The Chief Classifier manages protest procedures.

2.5 Trainee Classifiers:

- a) National Federations may nominate ITU certified national classifiers as trainees in order to follow the pathway to become international classifiers.
- b) ITU may appoint trainee classifiers if supported by their respective National Federation in order for them to be certified as a classifier;
- c) A trainee classifier may actively participate in an international panel or observe international athlete evaluation under supervision of a senior classifier in order to develop the necessary competencies and proficiencies to be certified by ITU as a Level 1 Classifier.

2.6 Classifier Competencies, Qualifications and Responsibilities:

- a) Classifiers shall be:
 - (i) Medical classifiers: medical and/or health professionals. For example: licensed medical doctors, physiotherapists, occupational therapists; these professionals must have knowledge of muscle power testing procedures and neurological health conditions;
 - (ii) Technical classifiers: sports specific and/or technical experts for example sport scientists, coaches, physical educators, experts in human movements' science or equivalent.
- b) Candidates must submit evidence of their relevant qualification with their CV.
- c) Candidates must have experience in the sport or classify nationally for their NF.
- d) All candidates must undergo the IPC Academy's course for Introduction to Para-Sport; (<http://ipc-academy.org>)
- e) In accordance with the ITU Classifier Education and Certification System, there are 4 levels of classifiers:
 - (i) National Classifier (NC);
 - (ii) Trainee Classifier (CT);
 - (iii) Level 1 International Classifier (Senior);
 - (iv) Level 2 International Classifier (Senior).
- f) The list of certified classifiers can be found under: http://www.triathlon.org/development/technical_officials/certification

2.7 Classification Panel:

- a) A Classification Panel is appointed by the Head of Classification in collaboration with Sport Department for a particular competition to determine the eligibility, the Sport Class and Sport Class Status of the athletes competing in that event under ITU Competition Rules;
- b) Classification panels should include a minimum of two classifiers, in which at least one medical classifier must be present;
- c) In exceptional circumstances, a panel may be set up with only one (1) medical classifier. In this case, the athletes can only be allocated a Review **sport class** status;
- d) Host NFs may request to have up to two (2) observers for classification procedures per event;
- e) Protest opportunities for athlete's sport classes are only available at ITU competitions when two (2) Classification Panels are available. The Chief Classifier may be a member of one of the panels;

3. Classification Responsibilities:

3.1 Athlete:

- a) Athletes who must undergo classification will need to report to the classification panel at their designated time and provide the panel the ITU PI Medical Diagnostic Form", completed by their medical doctor, or the "ITU VI Medical Diagnostic Form", completed by their ophthalmologist. A passport sized photo must be submitted along with other relevant and recent medical information. **It is mandatory for the medical conditions highlighted on page two of the PI Medical Diagnostics Form to submit relevant and recent medical information.** This could include, but should not be limited to: medical letters and reports detailing medical history, results of radiological examinations, and other diagnostic tests relevant to the athlete's medical condition;
- b) Failure to report for classification at the designated time, without reasonable explanation to the chief classifier will result in the athlete not being classified and not being able to compete at the paratriathlon event.
- c) Failure to provide the completed medical documentation during classification will result in the athlete being allocated a status of "PCS" (Provisional Competition Status) for that event, **only if the athlete has a health condition that presents as a permanent eligible impairment type. Refer to section 8.4 d).** In order to retain and preserve any results, ranking or award associated with that event, the athlete will need to submit all completed documents to ITU within 30 days after the race;
- d) **Failure to provide the completed medical documentation during classification and where there the athlete does not have an eligible impairment type, the athletes classification will not be able to be completed and the athlete will be allocated a status of "Classification not Completed (CNC). Refer to section 7.4.**
- e) Athletes must dress appropriately in sports clothes and bring all supportive equipment (prosthesis, orthoses, slings, etc.) to the classification appointment, including their bike, handbike and racing wheelchairs;
- f) English is the official language for the classification assessments. Athletes must be accompanied by an interpreter (if English is not their first or commonly spoken language) and/or by not more than one (1) representative of their NF. The athlete's representative shall not speak during the classification process, unless directed to do so by the classifiers;

- g) All athletes must present a true and accurate medical and sporting history and must cooperate fully in the examination process and observation phase of classification. Non-cooperation may lead to sanctions, as explained in sections 4.5 and 4.6.

3.2 Classifier:

- a) The role of classifiers is to act as impartial evaluators in determining an athlete's Sport Class and Sport Class Status;
- b) All **classifiers** must adhere to the IPC Classification Code of **Ethics** (http://www.paralympic.org/sites/default/files/document/141113161026885_2014_10_08+Sec+ii+chapter+1_1_IPC+Code+of+Ethics.pdf), which includes:
- (i) respect and value for athletes and their support personnel;
 - (ii) respect for the ITU Competition Rules;
 - (iii) respect for their colleagues;
 - (iv) understanding of the consequence of non-compliance with the ITU Competition Rules.
- c) Classifiers shall not have any relationship with an athlete or athlete support personnel or other official responsibilities during a competition if they are seen or perceived as a potential conflict of interest.

4. **Impairment Eligibility Criteria for Competition:**

- a) All athletes must have an international classification to compete in any ITU events;
- b) To be eligible for paratriathlon, the athlete must:
- (i) have a medically diagnosed condition that is permanent and meets one of these IPC Eligible Impairment types **recognized in paratriathlon**:

Impairment Type	Examples of Health Conditions that may cause such impairment
Impaired muscle power	Spinal cord injury, muscular dystrophy, brachial plexus injury, Erbs palsy, polio, spina bifida, Guillian – Barre syndrome.
Impaired passive range of movement	Ankylosis, arthrogyrosis, post burns joint contractures. Does not include hypermobility of joints.
Limb deficiency	Amputation resulting from trauma or congenital limb deficiency (dysmelia).
Hypertonia	Cerebral palsy, brain injury, stroke, multiple sclerosis.
Ataxia	Cerebral palsy, brain injury, multiple sclerosis, Friedrichs ataxia, spincerebellar ataxia.
Athetosis	Cerebral palsy, stroke, brain injury.
Vision Impairment	Myopia, tunnel vision, scotoma, retinitis pigmentosa, glaucoma, macular degeneration, congenital cataract.

- (ii) meet the ITU minimal disability criteria for the sport.

- c) **Every athlete requiring classification must submit to the ITU through its NF, no later than 4 weeks prior the competition, the Physical Impairment (PI) or Vision Impairment (VI) Medical Diagnostics Form and all relevant medical documents. This must also be presented at time of classification, as outlined in section 3.1.a.) of the Paratriathlon Classification Rules;**

5. **Minimum Impairment Criteria (MIC):** The Paratriathlon Classification system is based on evidence and science. It has been developed with the clear purpose to minimize the impact that impairments have in the outcome of competition through the activity of triathlon. To evaluate the impact of impairments on triathlon, classifiers assess all functional body structures through a physical and technical assessment using a point system and a weighing factor for each discipline of the sport (swimming, cycling and running). The total score determines the athlete's sport class.

5.1 Physical Impairments:

- a) PT2-PT4: The maximum possible score in the assessment would correspond to an athlete with full muscle power in the physical assessment and a full score in the Functional Athlete Profile (FAP). This is a value of 587.48. The score of 557.0 represents the minimal impairment criteria in paratriathlon for all physical impairments that do not fall under the PT1 or PT5 sport classes. The MIC equivalent to an athlete with the complete loss of a hand or throughout the wrist amputation.
- b) PT1: The maximum possible score in the assessment would correspond to an athlete with full muscle power in the PT1 physical assessment and a full score in the PT1 Functional Athlete Profile (FAP). This is a value of 667.15. The score of 640.0 represents the minimal impairment criteria in paratriathlon for all physical impairments that fall under the PT1 sport class. It is equivalent to a bilateral above the knee amputee with prosthesis in competition.

5.2 Vision Impairments (PT5):

- a) Has a visual acuity that is poorer than LogMar = 1.00 (6/60) measured with an ETDRS letter chart or an equivalent chart (Tumbling E) in the LogMAR format presented at a distance of at least 1 meter and/or;
- b) Has a visual field that is constricted to a diameter of less than 40 degrees. Within this class, the visual acuity may range from no light perception to a Single Tumbling E visual acuity of LogMAR = 1.60.

6. **Paratriathlon Sport Classes:**

Sport Class	Description	Range of Scoring
PT1	Athletes who predominantly use a wheelchair for their daily ambulation. Includes athletes with comparable activity limitation and an impairment of, but not limited to: muscle power, limb deficiency, hypertonia, ataxia, and athetosis. Athletes must use a recumbent hand-cycle on the bike course and a racing wheelchair on the run segment;	Max 640 points
PT2	Includes athletes with comparable activity limitation and an impairment of, but not limited to, limb deficiency, hypertonia, ataxia and or athetosis, impaired muscle power or range of movement. In both bike and run segments, amputee athletes may use approved prosthesis or other supportive devices	Max 454,9 points
PT3	Includes athletes with comparable activity limitation and an impairment of, but not limited to, limb deficiency, hypertonia, ataxia and or athetosis, impaired muscle power or range of movement. In both bike and run segments, the athlete may use approved prosthesis or other supportive devices.	From 455,0 to 494,9 points
PT4	Includes athletes with comparable activity limitation and an impairment of, but not limited to, limb deficiency, hypertonia, ataxia and or athetosis, impaired muscle power or range of movement. In both bike and run segments, the athlete may use approved prosthesis or other supportive devices.	From 495,0 to 557,0 points included

PT5	<p>Total or Partial visual Impairment (IBSA/IPC defined sub-classes B₁, B₂, and B₃): To be eligible, an athletes must:</p> <ul style="list-style-type: none"> • Have a visual acuity that is poorer than LogMar = 1.00 (6/60) measured with an ETDRS letter chart or an equivalent chart (Tumbling E) in the LogMAR format presented at a distance of at least 1meter and/or • Have a visual field that is constricted to a diameter of less than 40 degrees. Within this class, the visual acuity may range from no light perception to a Single Tumbling E visual acuity of LogMAR = 1.60. 	
-----	---	--

7. Athlete evaluation: Athlete Evaluation is the process by which an athlete is assessed by a classification panel in order for the athlete to be allocated a Sport Class and a Sport Class Status.

7.1 Athlete Evaluation Process:

- a) The Athlete Evaluation process consists of the following:
- (i) Physical Assessment: The classification panel should conduct a physical assessment of the athlete, to establish whether the athlete's health condition presents as an **eligible physical or visual impairment type and meets** the relevant Minimum Impairment Criteria;
 - (ii) Technical Assessment: The Classification Panel should conduct a Technical Assessment of the athlete which may include, but is not limited to, an assessment of the athlete's **physical** ability to perform, in a non-competitive environment, specific tasks and activities that are part of triathlon;
 - (iii) **A Classification Panel undertaking Athlete Evaluation may at any stage seek medical, technical or scientific opinion, with the agreement of the Head of Classification and/or a Chief Classifier. This expertise may only be sought if the Classification Panel feels that such expertise is necessary in order that it can allocate a Sport Class;**
 - (iv) Observation Assessment: The purpose of observation is to ensure that the result from the athlete's physical and technical assessments is reflected in the athlete's ability to perform in the competition.

7.2 Pre-Competition Evaluation:

- a) The Sport Department in conjunction with the Chief Classifier, the Technical Delegate and the LOC will coordinate and develop a classification schedule ensuring that all classifications will take place before the athletes' race briefing. A period of time shall be set aside for possible Classification Protests.
- b) As soon as an NF has registered an athlete to an event, the ITU Sport Department will confirm the athletes' class and status based on the ITU Classification Master List. All those with New (N) or Review (R) or Provisional Classification Status (PCS) or those protested under special circumstances (section 13.3) by the Head of Classification or Chief Classifier, shall be assigned a classification appointment. Sport Department will communicate the classification appointment (venue, assigned times) to the athletes' NF, the Head of Classification, the assigned Chief Classifier, the LOC and the assigned Technical Delegate, as soon as start lists are produced;
- c) An average of sixty (60) minute periods shall be designated for each appointment (with adequate meal times and breaks scheduled for the classifiers).

7.3 Athlete Presentation:

- a) The athlete, and their accompanying support staff, will report to classification reception **30 minutes prior** the designated time;
- b) Athlete identification will be verified;
- c) Required **medical** documentation will be checked and appropriate documentation completed;
- d) Athletes must attend classification with all competition equipment, including bicycles, handbikes and racing wheelchairs as outlined in section 3.1.e) **of the Paratriathlon Classification Rules;**
- e) The athlete will be checked for appropriate sports attire and equipment requirements in accordance with the ITU Competition Rules;
- f) Video footage, photography or other multimedia material may be utilized by the Classification Panel/s for all classification purposes connected to the competition;
- g) Athletes can only compete with prostheses, orthoses or special adaptive equipment that have been checked and approved during the Classification Procedure.

7.4 Classifications Not Completed (CNC):

- a) An athlete's classification will be considered not completed if the process of classification cannot be completed for one of, but not limited to, the following:
 - (i) Athlete had pain restrictions;
 - (ii) Insufficient medical information to give evidence of an athlete's impairment;
 - (iii) The athlete failed to attend one or more components of the classification evaluation;
 - (iv) Force majeure circumstances.

b) An athlete whose class cannot be completed will not be permitted to compete at that event or until classification has been completed.

7.5 Athlete Failure to Attend/Refuses Evaluation:

- a) If an athlete fails to attend evaluation, the athlete will not be allocated a Sport Class or Sport Class Status, and will not be permitted to compete at that competition;
- b) Should the Chief Classifier be satisfied that a reasonable explanation exists for the failure to attend the evaluation, an athlete will be given a second and final chance to attend the evaluation, if time allows;
- c) Failure to attend evaluation includes:
 - (i) not attending the evaluation at the specified time or place;
 - (ii) not attending the evaluation with the appropriate equipment/clothing and/or documentation.
- d) The athlete has a right to terminate the Classification Process at any time. If this occurs, that athlete will be asked to withdraw from the competition;
- e) If any athlete refuses to be classified, this will automatically exclude them from competition.

7.6 Non-Cooperation During Evaluation:

- a) An athlete who, in the opinion of the Classification Panel, is unwilling to participate in the evaluation shall be considered as being non-cooperative during evaluation;

- b) If the athlete fails to co-operate during the evaluation, they will not be allocated a Sport Class or Sport Class Status, and will not be permitted to compete in the competition;
- c) Should the Chief Classifier be satisfied that a reasonable explanation exists for the failure to co-operate during the evaluation, an athlete may be given a second and final opportunity to attend and co-operate or offered to voluntarily stop the classification process;
- d) The ITU will not permit any athlete found to have been non-cooperative during an evaluation to undergo any further evaluation for a minimum of six (6) months, starting from the date upon which the athlete failed to co-operate.

7.7 Intentional Misrepresentation of Skills and/or Abilities:

- a) An athlete, who, in the opinion of the Classification Panel, is intentionally misrepresenting skills and/or abilities, shall be considered in violation of the ITU Competition Rules;
- b) If the athlete intentionally misrepresents skills and/or abilities, the athlete will not be allocated a Sport Class or Sport Class Status and will not be permitted to compete at that competition;
- c) The Chief Classifier shall inform the ITU Sport Department of the athlete's intentional misrepresentation and provide all the evidence in a detailed report.
- d) ITU may consider any of the following actions:
 - (i) Not allow the athlete to undergo any further evaluation for a minimum of two (2) years from the date upon which the athlete intentionally misrepresented skills and/or abilities;
 - (ii) Remove any Sport Class or Sport Class Status allocated to the athlete from the Classification Master List;
 - (iii) Designate the athlete as IM (intentional misrepresentation) in the Classification Master List;
 - (iv) Sanction an athlete who, on a second separate occasion, intentionally misrepresents skills and/or abilities will receive a lifetime ban from any ITU events;
 - (v) Officially communicate the incident to the corresponding NF through written communication.

7.8 Consequences for Athlete Support Personnel:

- a) The ITU shall enforce sanctions on the personnel supporting the athlete, who assist or encourage an athlete to fail to attend their evaluation, to fail to cooperate, intentionally to misrepresent skills and/or abilities or disrupt the evaluation process in any other way;
- b) Those who are involved in advising any athlete intentionally to misrepresent skills and/or abilities are subject to sanctions that will be as severe as the sanctions enforced on the athlete;
- c) In this circumstance, reporting the athlete's support personnel to appropriate parties is an important step in deterring intentional misrepresentation by any party.

8. Sport Class and Sport Class Status Allocation:

8.1 Sport Class:

- a) A Sport Class will be allocated to an athlete by a Classification Panel following athlete evaluation;
- b) The decision of the Classification Panel to allocate a Sport Class is final and subject to challenge only as prescribed under a protest or appeal;
- c) A Sport Class that enables an athlete to compete in triathlon will be allocated if that athlete has an Eligible Impairment and **meets the Minimum Impairment** set by ITU;
- d) If an athlete does not have an Eligible Impairment nor has an Eligible Impairment that does not comply with the Minimal Disability Criteria, he or she will not be eligible to compete in triathlon. If an athlete is not eligible to compete he or she will be allocated Sport Class "Not Eligible".

8.2 Sport Class Non-Eligibility (NE):

- a) In circumstances where the sport class Non-Eligible is allocated, the athlete **will be offered the right to be reassessed** by a second classification panel at the earliest classification opportunity. If no second panel is available, at a specific event, the athlete will be **assigned NE Review** and will not be permitted to compete at that competition. The ITU will communicate to the athlete and NF the next available opportunity for classification review;
- b) None of the classifiers involved in the first NE allocation should be involved in the resolution by a second panel in at least six (6) months since the first assessment took place;
- c) NE Confirmed (C) status will be assigned if the second panel also determined the athlete's class as Non-Eligible (NE). If there is a change in medical condition, athletes may resubmit such documentation in order to request a review of classification according to section 12.

8.3 Sport Class Status:

- a) A Sport Class Status is allocated to an athlete to indicate athlete evaluation requirements and protest opportunities after the assessment;
- b) The designation of a Sport Class Status assists in identifying athletes who:
 - (i) Have not previously been classified (New – "N");
 - (ii) Require a review of their sport class (Review – "R");
 - (iii) Already have a recognized Sport Class (Confirmed – "C");
 - (iv) Provisional classification status ("PCS");
 - (v) Under Protest.**

8.4 Assignment of Sport Class Status:

- a) NEW (N):
 - (i) Sport Class Status N is assigned to an athlete that has not been previously evaluated by an international Classification Panel and has not had an entry Sport Class verified by the ITU;
 - (ii) Sports Class Status N includes athletes who have been allocated a Sport Class by their National Federation for entry purposes;

- (iii) Sports Class Status N athletes must undergo classification evaluation before competing at an ITU Event. The athlete's Sports Class is still subject to protest according to ITU Paratriathlon First Appearance requirements.
- b) REVIEW (R):
- (i) Sport Class Status R is assigned to an athlete who has been previously evaluated by an International Classification Panel, but for reasons as determined by ITU, requires a review of their Sport Class. Such reasons could include **but not limited to:**
- Athlete has a fluctuating impairment;
 - Athlete has not reached maturity;
 - Athlete has a new injury or medical condition.
 - **Athlete has had a medical review request approved (MR)**
 - **The athlete is currently under protest**
- (ii) The athlete's Sports Class is still subject to protest, according to ITU Paratriathlon First Appearance requirements. This includes athletes who are protested, but for whom no second panel is available at the competition, or for athletes who have been reassessed after protest, but who have not been observed in competition by a second panel;
- (iii) Athletes with Sport Class NE remain non-eligible until a second classification panel is able to examine the athlete;
- (iv) R status must be assigned to athletes who are assessed by a panel composed of only one classifier;
- (v) Sports Class Status R Athletes (with no fixed review) must complete evaluation prior to competing at ITU events.
- c) CONFIRMED (C):
- (i) Sport Class Status C is assigned to an athlete if he/she has been previously evaluated by an international Classification Panel and the panel has determined that the athlete's Sport Class will not change;
- (ii) ITU recognizes that athletes with Sport Class "C" are not required to complete evaluation prior to competition and their sport class will not be altered before or during competition, except in the case of a protest lodged under exceptional circumstances (section 13.3).
- d) PROVISIONAL CLASSIFICATION STATUS "PCS":
- (i) If an athlete is attending an event where no classification is offered, he/she will be able to obtain a provisional classification from **ITU** and will need to provide the required provisional classification forms **and Medical Diagnosis form no later than four weeks prior the competition. If the athlete has a health condition that presents as a permanent eligible impairment type.** The athlete will receive a status PCS;
- (ii) This will only happen if there is still at least one classification opportunity in the season that the athlete can attend to ratify the classification status. For the athlete to preserve the results and ranking points achieved in the current season, he/she must attend the available classification opportunity in that season;

(iii) An athlete with a Provisional Classification Status will have no protest opportunities.

9. First appearance:

- a) First Appearance for N and R Sports Class Status athletes is generally defined as the first time the athlete competes in an ITU where they are being classified.
- b) Athletes with N or R status cannot be allocated a C Status, until they have completed the First Appearance, in order to allow the classifiers and other competitors/nations to:
 - (i) Observe the athlete in competition and complete the classification evaluation;
 - (ii) Protest the allocated Sports Class provided the athlete has not already been protested by any of the parties under section 13.1 b.)

10. Reporting of Classification Results:

- a) ITU Classification Evaluation Cards completed at an ITU event should be signed by all of the members in the Classification Panel and the athlete;
- b) The Chief Classifier has the responsibility to inform all relevant parties of the outcomes of Athlete Evaluation after the classification sessions;
- c) Once the Classification Panel has allocated the Sport Class, verbal notification of the athlete's Sports Class is provided to the athlete on the ITU Classification Certification Form. Even if the athlete decides not to take the form, it is considered that the athlete has been informed in person about the outcome of classification;
- d) A Confirmed or Review athlete's Sports Class Status can only be allocated after the First Appearance has been completed;
- e) The Chief Classifier must liaise with the Race Referee and the LOC to ensure start lists are updated accordingly after each of the classification sessions;
- f) A list with the complete Classification results must be posted and available to all NFs at the Paratriathlon briefing. This posting at the beginning of the briefing will set the official time from which protests can be launched until 60 minutes after the time the classification outcomes are posted at the briefing.
- g) After the race, final Classification results will be posted in the area the TD had designated at the briefing. It is the NFs and athletes responsibility to check and refer to these results in case they are potentially involved in further completion of their assessment, a re-classification or a protest;
- h) The completed Classification Evaluation Card will be filed in a protected database and maintained by ITU. NFs may request from ITU a copy of an athlete's classification evaluation after the competition;
- i) Official confirmation of Sport Class and Sport Class Status will be sent to the relevant National Federation in the form of a Classification Certification, upon written request to the ITU;
- j) The ITU Paratriathlon Master List will be updated after each event within 7 days where classification takes place;
http://www.triathlon.org/about/downloads_category/paratriathlon
- k) An official report must be submitted after the event from the Chief Classifier to the ITU Technical Delegate in order to be included in the events' post-race report.

11. Changes in Sport Class:

11.1 Before Competition:

SCENARIO	OUTCOME
a) Athlete undergoes classification Athlete changes Sport Class	Chief Classifier notifies athlete/NF through posting of the results at the briefing and informs Race Referee. Start list updated for his/her old and new category Reassigning of bib number according to TD decision
b) Athlete undergoes classification Athlete is declared non-eligible (NE) by first assessment panel	Review status is assigned and must be seen by a second panel at the earliest opportunity. 2nd Panel NOT available: <ul style="list-style-type: none"> Athlete remains NE with R" status and cannot compete at the event. Athlete is removed from the start list. Does not appear on the results. 2nd Panel available: <ul style="list-style-type: none"> If an athlete is declared NE, status becomes confirmed C. Athlete cannot compete at the event. Athlete is removed from the start list. Does not appear on the results. Athlete must be informed by the classifiers that he/she can register for the AG race if the timing of races allows for it. If athlete is eligible, athlete should remain on the start list with the designated sport class allocated by the second panel.

11.2 After Competition (includes observations during competition):

SCENARIO	OUTCOME
a) Athlete changes Sport Class as a result of the observation	Chief Classifier notifies athlete/NF through final classification results posting and informs Race Referee. Race Referee decides if the change is applicable for the given event and notifies Timing so athlete is correctly ranked in new category. Past results/rankings may be revisited.
b) Athlete's Sport Class is protested	Review status is assigned and must be seen by a second panel at the earliest opportunity. If no 2nd panel is available: <ul style="list-style-type: none"> Results and sport class stand as they are and a Note should be added in the official results indicating the athlete has been protested and is pending resolution. Athlete is made Review status. If a 2nd panel is available, the following scenarios can occur: <ul style="list-style-type: none"> Confirms the decision of the first panel, results and sport class stand as they are. If the 2nd panel changes the decision of the 1st panel, the subsequent procedures are described in 11.2a) If the athlete is declared non-eligible status becomes review ®. Athlete is shown with no ranking after the DSQ and DNF IRM codes with an NE as total time.
c) Athlete is declared non-eligible (NE) due to either observation	If a 2nd panel is available procedure as in 11.2b) is followed. If a 2nd Panel is NOT available:

	The athlete remains NE with " status. The athlete is shown with no ranking after the DSQ and DNF IRM codes with an NE as total time.
--	--

12. Medical review request: Re-classification:

- a) An athlete who has reason to believe that his or her Impairment and Activity Limitations are no longer consistent with the Sport Class he or she was assigned under his/her current classification certification, may request the ITU to undergo a new classification appointment. The means by which this can take place is referred to in these Rules and Regulations as "the Medical Review Process" and the means by which a request for such review is referred to as "a Medical Review Request";
- b) The National Federation must make a Medical Review Request;
- c) A Medical Review Request may be made if an athlete has been allocated:
 - (i) A Sport Class with Sport Class Status Confirmed (C), or;
 - (ii) A Sport Class with Sport Class Status Review (R), if the athlete has been allocated a Fixed Review Date.
- d) A Medical Review Request must be made by completing the ITU Medical Review Request Form. The athlete and his or her NF must ensure that the Medical Review Request abides by the following provisions:
 - (i) it must explain that the athlete's relevant impairment has changed since the last athlete evaluation to an extent that the athlete's ability to perform the sport activities has changed and may not reflect the criteria for that current class;
 - (ii) it must be completed by an appropriately qualified health professional and include all relevant supporting documentation in English or with a certified English translation;
 - (iii) a non-refundable fee of 100\$ USD must be paid.
- e) Each Medical Review Request will be assessed by ITU to ensure that all requisite information, documentation and fee have been provided. Once the Medical Review Request is complete, the Head of Classification will, in conjunction with such third parties as he or she considers appropriate, decide whether or not the Medical Review Request is accepted;
- f) If the Medical Review Request is accepted the athlete's Sport Class Status will be amended from Confirmed to Review; or the Athlete's Fixed Review Date will be set and the athlete will be requested to undertake Athlete Evaluation at the next available opportunity;
- g) If the Medical Review Request is denied, the applicant may appeal this decision to the ITU Arbitration Tribunal.

13. Classification Protest:

13.1 General:

- a) The term "Classification Protest" refers to the procedure by which a formal objection to an athlete's Sport Class is made and subsequently resolved;
- b) A Classification Protest may be resolved on site if there is a second classification panel or at the next classification opportunity. Classification Protests shall only be submitted by the athlete or by a designated representative of:
 - (i) a National Paralympic Committee (NPC);

- (ii) a National Federation (NF);
 - (iii) the ITU Head of Classification or Chief Classifier.
- c) The timeline to submit protests is defined under section 13.4 of the Paratriathlon Classification Rules;
 - d) An athlete's Sport Class can only be protested once. A Classification Protest in relation to a Sport Class allocated by a classification panel may only be resolved by another classification panel;
 - e) A Classification Protest should be resolved in a manner that minimizes the impact on competition participation, schedules and results;
 - f) Any member of a classification panel may not, within six (6) months of the allocation of a sport class to an athlete, be involved in a classification protest of that athlete.

13.2 Classification Protest Opportunities:

- a) The Sport Class Status that is allocated to an athlete indicates the classification protest opportunities that are available in respect of that athlete's Sport Class. The Sport Class Status also indicates which parties may submit such a Classification Protest;
- b) An NPC or NF may protest against the Sport Class allocated to an athlete from their own or another nation only in accordance with the provisions outlined in section 13.4 of the Paratriathlon Classification Rules;
- c) The Chief Classifier or the ITU Head of Classification may protest against the classification of any athlete's Sport Class, in accordance with the provisions outlined under sections 13.3 and 13.4 of the Paratriathlon Classification Rules;
- d) A Classification Protest may be made against any athlete with a New (N) or Review (R) Sport Class Status (by any NPC and/or NF, or by the Chief Classifier or the ITU Head of Classification), following the evaluation of an athlete and allocation of the Sport Class before, during or after the race. Following the resolution of the Classification Protest, the athlete shall be designated a Sport Class and a Sport Class Status according to the chart in section 13.4 of the Paratriathlon Classification Rules;

13.3 Protest Under Exceptional Circumstances:

- a) Exceptional Circumstances will arise if a Chief Classifier or the ITU Head of Classification believes that an athlete's confirmed Sport Class no longer reflects that athlete's ability to compete equitably within that Sport Class;
- b) Exceptional Circumstances may result from:
 - (i) change in the degree of impairment of an athlete;
 - (ii) an athlete demonstrating significantly less or greater ability prior to, or during, competition, which does not reflect the athlete's current Sport Class;
 - (iii) an error made by a Classification Panel, which has led to the athlete being allocated a Sport Class, which is not in keeping with the athlete's ability;
 - (iv) Sport Class allocation criteria having changed since the athlete's most recent evaluation.
- c) A Classification Protest made in exceptional circumstances shall follow the timeline described below:
 - (i) The ITU will communicate to the NF the protest against a specific athlete and will indicate the next opportunity when the athlete must undergo classification. This can apply before or during a competition;

- (ii) The protested athlete will automatically be assigned the status "R" for their current class.

13.4 Protests Before, During and After Competitions:

a) Before the race:

- (i) This period starts once the athlete and/or NF have been informed of the athlete's Sport Class or once the classification results have been posted;
- (ii) Classification Protests may be submitted by the athlete or:
 - an NF authorised representative to submit protests; and/or;
 - an ITU Chief Classifier or the ITU Head of Classification.
- (iii) the Chief Classifier, or a person designated for that event, shall be the person authorised to receive Classification Protests on behalf of ITU at that event.
- (iv) Classification Protests must be submitted to the Chief Classifier **within sixty (60) minutes of the end of the athlete's classification assessment** or within sixty (60) minutes of the official publication of the Classification Results at the athlete's briefing.

b) During/after the race:

- (i) Classification Protests may be submitted by the athlete or:
 - an NF authorised representative to submit protests (for example, the Chef de Mission or Team Manager); and/or
 - an Chief Classifier or the Head of Classification;
- (ii) the Chief Classifier, or a person designated for that event, shall be the person authorised to receive Classification Protests on behalf of ITU at that event.
- (iii) The intent to issue a Classification Protest must be communicated to the Chief Classifier within 5 minutes after the Classification outcomes have been posted in the finish area or 5 minutes from the moment the athlete involved in a protest crosses the finish line, whichever occurs last. Once the intention to protest is initiated, the time limit will be extended by 15 minutes at which time all protest documents need to be submitted.
- (iv) Race results can only become official after this process is completed if there have been any protests.

Athlete Sport Class Status	Protest by own or other NPC/NF		Protest by Chief Classifier or Head of Classification		Possible Outcome	
	Before	During / After	Before	During / After	Before	During / After
NEW (N)	YES	YES	YES	YES	N/R/NE	R/C/NE
PROVISIONAL CLASSIFICATION STATUS (PCS) (Athlete cannot be protested as have not been officially classified or in the case of not	NO	NO	NO	NO		

having submitted an MDF, an eligible impairment has not yet been identified.)						
REVIEW (R)	YES	YES	YES	YES	R/C/NE	R/C/NE
CONFIRMED (C)	NO	NO	YES*	YES*	R/C/NE	R/C/NE

(*) Athletes with Sport Class Status (C) may only be subjected to a Classification Protest by the Chief Classifier or the Head of Classification under exceptional circumstances.

13.5 Classification Protest Procedures:

- a) Classification Protests must be submitted in English by using the ITU Classification Protest Form (http://www.triathlon.org/about/downloads_category/paratriathlon)
- b) The following information and documentation must be submitted with this form:
 - (i) The name and nation of the athlete whose sport class is being protested;
 - (ii) Details of the decision being protested;
 - (iii) The reason for the protest;
 - (iv) Other documents and evidence to support the protest **different than the ones presented at the time of classification;**
 - (v) The signature of the protester.
- c) A refundable deposit of **100 USD** (or its equivalent) must accompany all classification protests. The deposit will be retained by ITU if the protest is denied;
- d) Upon receipt of the Classification Protest Form, the Chief Classifier shall conduct a review to determine whether all necessary information is included. If it appears to the Chief Classifier that the Classification Protest Form has been submitted without all necessary information, the Chief Classifier shall dismiss the Classification Protest and notify all relevant parties. If the Classification Protest is accepted, the Chief Classifier shall notify all relevant parties of the time and date for the subsequent protest evaluation;
- e) **The Chief Classifier shall appoint a Classification Protest Panel to conduct an evaluation of the athlete, referred to as the "Classification Protest Evaluation". All documentation submitted with the Classification Protest Form shall be provided to the Classification Protest Panel. Classification Protest Panels shall conduct the Classification Protest Evaluation without reference to the previous Classification Panel, which allocated the athlete's most recent Sport Class. The 2nd panel may request any video footage from the first panel taken during observation in 1st appearance. The conditions of a Classification Protest Panel are those included in section 13.1 f) of the Paratriathlon Classification Rules;**
- f) Reclassifications for athletes protested before the race will be carried out at the classification venue as soon as possible after the classification schedule has been completed;
- g) Reclassifications for athletes protested during the race will be carried out if possible at a facility close to the finish line of the race location; **If no second panel is available, all parties will be advised and the athlete will be reclassified at the earliest opportunity and given a class status of review. Provided the athlete is not NE, the athlete is**

permitted to compete at that competition and competition results and sports class stand until reclassification is done by a second panel;

- h) All relevant parties shall be notified of the Classification Protest decision.

14. Classification Appeal:

14.1 General:

- a) The term "Classification Appeal", as used in this document, refers to a procedure by which a formal objection to the manner in which classification procedures have been conducted, is submitted and subsequently resolved.

14.2 Classification Appeal Jurisdiction:

- a) The Classification Appeal Body shall have jurisdiction to review classification decisions in order to:
 - (i) ensure that all appropriate Sport Class allocation procedures have been followed;
 - (ii) ensure that all appropriate Classification Protest Procedures have been followed.
- b) No Classification Appeal Body shall have jurisdiction to review the merits of an allocation of Sport Class or Sport Class Status. Under no circumstances shall the Classification Appeal Body modify a classification decision by allocating a new Sport Class and/or Sport Class Status to an athlete;
- c) The Classification Appeal Body shall hear Classification Appeals only in cases in which all other available remedies, including but not limited to Classification Protest procedures have been exhausted;

14.3 Timeline for Appeal Submission:

- a) Submission of an appeal against classification: Classification Appeals may be submitted and commenced no later than 30 days after the classification process took place, by submitting a Notice of Classification Appeal to the ITU Secretary General. The ITU shall promptly transmit a copy of the Notice of Classification Appeal to all parties involved:
 - (i) Only an NF (or NPC at the Paralympic Games) has the right to submit an Notice of Classification Appeal in English by using the ITU Classification Appeal Form; (http://www.triathlon.org/about/downloads_category/paratriathlon)
 - (ii) A refundable deposit of 150 USD (or equivalent) must accompany all appeals. The deposit will be retained by the ITU, if the appeal is denied;
 - (iii) Upon receipt of a Notice of Classification Appeal, ITU shall conduct a review to determine whether all other available remedies have been exhausted by the party bringing the Classification Appeal. If not, ITU shall issue a written dismissal of the Classification Appeal.

14.4 Classification Appeal Procedures:

- a) If all other available remedies have been exhausted, ITU shall:
 - (i) advise all relevant parties that a Classification Appeal Body will be constituted for the purposes of hearing the Classification Appeal;
 - (ii) send a copy of the Notice of Classification Appeal, and all documents, evidence and details of witnesses to all parties involved; advise the parties involved that they must, within the 28th day after the Notice of Classification Appeal has been received, submit a list of all documents to the Classification Appeal Body, evidence and expert witnesses to be offered by the opposing party in relation to the Classification Appeal;

- (iii) set a location for the hearing and date: the Classification Appeal Body shall have the right, in its sole discretion, to conduct a hearing; either live, by telephone conference or by video conference.

14.5 Classification Appeal Body and Hearing Procedures:

- a) The Classification Appeal Body should include no less than three (3) individuals, who have at no time been involved with, or informed of, the dispute brought before the Classification Appeal Body;
- b) Classification Appeal Body members will be nominated by the ITU Secretary General;
- c) The ITU may request the IPC the formation of an Appeal Body to deal with a specific appeal;
- d) In order to ensure a level of independence, a majority of the members of the Classification Appeal Body shall not have any other official responsibility in ITU;
- e) The Classification Appeal Body may designate Counsel to assist it in the Hearing;
- f) ITU and the applicable NPC or NF shall have the right to be represented by Counsel and, if necessary, to engage an interpreter approved by the Classification Appeal Body;
- g) Not more than two representatives of any party, excluding the athlete and any interpreter, shall be entitled to participate in the Hearing;
- h) Subject to the Classification Appeal Body's discretion, each party shall have the right to offer documentary evidence, to submit a hearing memorandum or brief, and to call witnesses.

14.6 Classification Appeal Decision:

- a) The Classification Appeal Body shall issue a written decision resolving any Classification Appeal after the Hearing. The decision shall be provided to all parties;
- b) The Classification Appeal Body shall either affirm the decision that has been appealed against or overrule the decision. If the decision is overruled, the Classification Appeal Body's written opinion shall specify the procedural error committed and shall direct the appropriate party to the decision in a manner consistent with Classification Appeal Body's instructions;
- c) ITU shall be responsible for ensuring that the Classification Appeal Body's directives are followed in a timely manner;
- d) Classification Appeal decisions are final and are not subject to any further Classification Appeal within the ITU/IPC.

14.7 Confidentiality:

- a) Classification Appeal Proceedings are confidential. The parties and the Classification Appeal Body shall not disclose facts or other information relating to the dispute or the proceedings to any person or entity excluding, to the extent necessary to prosecute or defend the Classification Appeal:
 - (i) employees or agents of a party;
 - (ii) witnesses whose testimony may be offered during the Classification Appeal;
 - (iii) Counsel, consultants or interpreters engaged for purposes of the Classification Appeal.
- b) At this sole discretion, the Classification Appeal Body may require all persons who attend a hearing to sign a Confidentiality Agreement. Any individual refusing to sign said agreement may be excluded from the Hearing.

15. Classification data protection:

- a) Classification data is personal information and/or sensitive personal information provided by an athlete and/or national federation and/or third party to ITU in connection with classification.
- b) All classification data processed by ITU must be accurate, complete and kept up to date and be relevant or necessary in relation to classification.

SECTION B: CLASSIFICATION ASSESSMENT METHODOLOGY

16. Medical Assessment for Physical Impairments:

- a) Muscle Power will be assessed based in general on the Daniels and Worthingham (D&W) scale published in 2006, version 9. The scale has 6 levels from 0-5. Plus or minus grades can't be recorded. That is, an athlete will score a 0, 1, 2, 3, 4, or 5, not a 2.5 or 3.5 for example;
- b) The athlete is passively taken through the anatomical range of the key movement to assess the available range of movement. (ROM) The athlete then actively moves through their available range against gravity and subsequently with resistance provided through the available range by the assessor or with gravity eliminated to identify the muscle power level;
- c) The overall values for each muscle group are factored according to the relevance of each of the three disciplines (Swim, Bike and Run). Finally, the overall Swim, Bike and Run scores are weighed against proportionate mean values that relate to the specific distances for each discipline segment;
- d) The Muscle Power testing accounts for 75% of the total athlete's score;
- e) Full Range of Movement (ROM) is measured as full available ROM;
- f) Anatomical range is identified for all key movements. E.g. Neck Flexion: 0-40;
- g) Muscle Testing (Power scale):
 - 0 Total lack of voluntary contraction
 - 1 Faint contraction without any movement of the limb (trace, flicker)
 - 2 Contraction with very weak movement through full range of motion when gravity is eliminated (poor)
 - 3 Contraction with movement through the complete joint range against gravity
 - 4 Contraction with full range movement against gravity and some resistance (good)
 - 5 Contraction of normal strength through full range of movement against full resistance.

(Daniels and Worthingham 2006)

NOTE: Athletes with neurological impairments, will be requested to perform some neurological tests for upper motor neuron lesions and other novel motor and coordination tests to ensure there is evidence of hypertonia, athetosis and or ataxia to confirm they have an eligible impairment for Paratriathlon before they can continue the standard medical, technical and observation assessments.

17. Technical Assessment for Physical Impairments:

- a) Athletes will be questioned on and requested to perform sport specific and novel tests as part of the technical assessment. This is called the "Functional Abilities Profile" assessment. Testing protocols have been identified through current research;
- b) The Technical Tests account for 25% of the athlete's total score.

18. Assessment For Athletes With Vision Impairment:

- a) The assessment of athletes who may fall into the PT5 sport class will be done according to the International Blind Sports Association Federation's procedures, defined under:
(<http://www.ibsasport.org/documents/files/68-1-IBSA-Classification-Rules-and-Procedures.pdf>)

19. Multiple Impairments:

- a) If an athlete has a secondary or even a tertiary recognized permanent impairment by the ITU Classification system that leads to further activity limitation, these impairments will also be accounted for in the overall scoring.

20. Considerations:

- b) This methodology measures the impact of impairment on activity limitation for Sprint Distance Triathlon. The Sport Classes defined by this classification system are applied across all disciplines in ITU for athletes with an impairment

21. Definitions:

Term	Definition
Activity Limitation	Difficulties an individual may have in executing activities.
Appeal	A formal objection to the manner in which Classification procedures have been conducted is submitted and subsequently resolved.
Athlete	The competitors who register for and compete in ITU events.
Athlete Evaluation	The process by which an Athlete is assessed in accordance with these rules and regulations.
Athlete Support Personnel	Any coach, trainer, manager, interpreter, agent, team staff, official, medical or paramedical personnel working with or treating Athletes participating in or preparing for training and/or Competition.
Chief Classifier	The classifier responsible for the direction, administration, co-ordination and implementation of classification matters for a specific competition.
Classification	A structure for Competition to ensure that an Athlete's Impairment is relevant to sport performance, and to ensure that the Athlete competes equitably with other Athletes.
Classification Evaluation Period	The timeframe prior to the commencement of Events at a Competition within which Physical and Technical Assessment typically takes place.
Classification Master List	The list, made available by ITU that identifies the Athletes that have participated in International Classification.
Classification Panel	A group of Classifiers assembled to determine Sport Class and Sport Class Status in accordance with these rules and regulations.
Classification Personnel	All persons involved in or associated with the process of Athlete Evaluation, including the Head of Classification, Classifiers, Chief Classifiers and Trainee Classifiers.

Classifier	A person certified by ITU or IBSA/IPC to evaluate Athletes as a member of a Classification Panel.
Competition	A series of individual Events conducted together under the jurisdiction of ITU.
Competition Season	The timeframe within which Competitions are held for a particular sport. For summer sports, the Competition Season runs from January 1st of a calendar year until December 31st of the same calendar year. For winter sports, the Competition Season runs from July 1st of a calendar year until June 30th of the next calendar year.
Conflict of Interest	A set of circumstances that creates a risk that professional judgment or actions regarding a primary interest will be unduly influenced by a secondary interest.
Counsel	A barrister or other legal adviser conducting a case
Effective Date	The date upon which these Rules come into force.
Eligible Impairment	An Eligible Impairment is an Impairment the existence of which is a pre-requisite for an Athlete to meet the Minimum Disability Criteria for the sport of triathlon.
Entry Sport Class	A Sport Class allocated to an Athlete by a National Body prior to an ITU Competition to indicate the Sport Class with which the Athlete intends to compete. An Entry Sport Class is an estimate and has no binding effect upon either the Athlete or the body responsible for organising and managing the relevant Competition.
Event	A sub-set of a Competition that requires specific technical and sporting skills.
Fixed Review Date	A date prior to which an Athlete who has been designated with Sport Class Status Review (R) will not be required to undertake Athlete Evaluation, regardless of whether or not that Athlete competes at any Competition. Unless otherwise specified by the Classification Panel, the Fixed Review Date is 1st January.
Head of Classification	A Classifier responsible for all direction, administration, co-ordination and implementation of Classification matters for Triathlon.
Hearing	An act of listening to evidence in a court of law or before an official, especially a trial before a judge without a Competition Jury
Impairment	Problems in body function or structure such as a significant deviation or loss.
Intellectual Impairment	A type of Impairment, which is defined as a limitation in intellectual functioning and adaptive behavior as expressed in conceptual, social and practical adaptive skills. This impairment originates before the age of 18.
International Classification	Athlete Evaluation that is conducted in full compliance with these rules and regulations.
IPC	International Paralympic Committee.
IPC Classification Code	The IPC Classification Code 2007 and accompanying International Standards and any subsequent version or versions of the same.
IPC Classifier Code of Conduct	A set of rules to outline the responsibilities, to guide behavior and decisions and to identify best practice for an individual Classifier, which is part of the IPC Classification Code International Standard of Classifier Training.
IPC Code of Ethics	The ethical standard that will be applied consistently within the Paralympic Movement, and will be applicable to all IPC sanctioned Events, Competitions and activities.

IPC Handbook	The IPC Handbook is the primary governance instrument for the IPC in its capacity as both an International Federation and the ruling body for the Summer and Winter Paralympic Games. All persons who are subject to the jurisdiction of the IPC are required to abide by its provisions.
Medical Intervention	Any intervention such as surgery, pharmacological intervention or other treatment, which affects the Athlete's Eligible Impairment.
Medical Review	The process by which an Athlete can apply to ITU to undergo Athlete Evaluation, in order that the Athlete's Sport Class may be reviewed to ensure that the Athlete's Sport Class remains a fair allocation.
Minimum Disability Criteria	The standards set by ITU in relation to the degree of Eligible Impairment that must be present in order that an Athlete is deemed to be eligible to compete in the sport of Triathlon.
National Federation	National Triathlon Governing body affiliated with ITU.
Not Eligible	Consequence of not meeting the eligibility criteria.
Observation Assessment	The means by which a Classification Panel may complete Athlete Evaluation, if it considers that the only fair way in which it can complete Athlete Evaluation is to observe the Athlete performing the specific skills associated with the sport of Triathlon either prior to or during an Event.
Physical Assessment	The means by which a Classification Panel will determine whether or not an Athlete has an Eligible Impairment and whether that Eligible Impairment complies with the Minimum Disability Criteria.
Physical Impairment	A group of Eligible Impairments affecting an Athlete's biomechanical execution of sporting activities, comprising ataxia, athetosis, hypertonia, impaired muscle power, impaired range of movement, limb deficiency, leg length difference and short stature.
Protest	The procedure by which a formal objection to an Athlete's Sport Class is submitted and subsequently resolved.
Protest Panel	A Classification Panel formed to conduct Athlete Evaluation in respect of an Athlete's Sport Class, where that Sport Class is the subject of a Protest.
Recognised Competition	An umbrella term for triathlon competitions, ITU Sanctioned Competitions and ITU Approved Competitions as defined in the ITU Competition Rules.
Sport Class	A category defined by ITU in which athletes are categorized by reference to an Activity Limitation resulting from impairment.
Sport Class Status	A Category allocation to each Athlete to indicate evaluation requirements and Protest opportunities.
Technical Assessment	The assessment of an Athlete's ability to perform the tasks and activities required to participate in the sport of Triathlon.
Tracking Code	A temporary designation applied to a Sport Class that indicates that a Sport Class is subject to final determination after Observation Assessment has taken place.
Visual Impairment	An Impairment of the eye structure, optical nerves or optical pathways, or visual cortex of the central brain, which adversely affect an Athlete's vision.

29. APPENDIX H: PRIZE MONEY BREAKDOWN:

1. Introduction:

- 1.1. The ITU Prize Money Percentages were created to provide a fair and equitable formula to distribute prize money to athletes;
- 1.2. If an ITU Event Organiser wants to modify these percentages, they must request a rule exception. If the modification is approved, it must be posted on the ITU event’s webpage and on www.triathlon.org;
- 1.3. The amount and depth of prize money must be equal for women and men. There is no modification to this.

2. Percentages:

- 2.1. The table below shows the five basic prize money percentages;
- 2.2. For an easy tool to calculate the prize money percentage based on the event prize money, please visit www.triathlon.org:

	Top 20 (150 001 USD and more overall prize money)	Top 15 (50 001 -150 000 USD and more overall prize money)	Top 10 (10 001 – 50 000 USD overall prize money)	Top 5 (3 001 – 10 000 USD overall prize money)	Top 3 (3 000 USD and less overall prize money)
1.	23,00%	25.00%	25.00%	30.00%	50.00%
2.	18,00%	20.00%	20.00%	25.00%	30.00%
3.	14,00%	15.00%	15.00%	20.00%	20.00%
4.	10,00%	10.00%	10.00%	15.00%	
5.	8,00%	7.00%	8.00%	10.00%	
6.	6,00%	6.00%	7.00%		
7.	4,00%	5.00%	6.00%		
8.	3,00%	3.00%	4.00%		
9.	2,30%	2.25%	3.00%		
10.	1,90%	1.75%	2.00%		
11.	1,60%	1.50%			
12.	1,40%	1.25%			
13.	1,20%	1.00%			
14.	1,10%	0.75%			
15.	1,00%	0.50%			
16.	0,90%				
17.	0,80%				
18.	0,70%				
19.	0,60%				
20.	0,50%				

30. **APPENDIX I: ITU RELATED MULTISPORTS:**

- Triathlon
- Long Distance Triathlon
- Aquathlon
- Duathlon
- Long Distance Duathlon
- Winter Triathlon
- Cross Triathlon
- Cross Duathlon
- Indoor Triathlon

31. APPENDIX J: ITU EVENTS AND ITU EVENT CATEGORIES:

ITU Events

- World Championships
- World Triathlon Series
- World Triathlon Series Grand Final
- World Series
- World Cup
- Continental Championships
- Continental Cup
- Continental Cup Premium
- Continental Cup Final
- Continental Tour Event
- International Event

ITU Event Categories

- Elite
- U23
- Junior
- Youth
- Elite Paratriathlon
- Open Paratriathlon
- Age Group
- Team Relay

ITU events	Categories
World Championships. Triathlon Standard Distance	U23, Age Group
World Championships. Triathlon Sprint Distance	Junior, Age Group, Elite Paratriathlon, Open Paratriathlon.
World Championships. Triathlon Team relay	Elite. U23 & Junior (combined)
World Championships. Triathlon Long Distance	Elite, Age Group, Paratriathlon
World Championships. Duathlon Standard Distance	Elite, U23, Age Group
World Championships. Duathlon Sprint Distance	Junior, Age Group, Paratriathlon
World Championships. Duathlon Team relay	Elite. Junior.
World Championships. Duathlon Long Distance	Elite, Age Group, Paratriathlon
World Championships. Winter Triathlon.	Junior, U23, Elite, Age Group. Team Relay. Paratriathlon PT ₂ , PT ₃ and PT ₄
World Championships. Aquathlon.	Junior, U23, Elite, Age Group, Paratriathlon
World Championships. Cross Triathlon.	Junior, U23, Elite, Age Group. Team Relay. Paratriathlon PT ₂ , PT ₃ and PT ₄
World Series. Triathlon. (Both Standard and Sprint)	Elite
World Series Grand Final. Triathlon.	Elite
World Cup. Triathlon. (Both Standard and Sprint)	Elite
World Cup. Winter Triathlon	Elite
World Series. Duathlon (Both Standard and Long)	Elite
World Series. Long Distance Triathlon	Elite
Continental Championships. Triathlon Standard distance	Elite, U23, Age Group
Continental Championships. Triathlon Sprint Distance	Elite, U23, Junior, Age Group, Paratriathlon
Continental Championships. Triathlon Long Distance.	Elite, Age Group, Paratriathlon.
Continental Championships. Triathlon team relay	Elite, Junior, Youth.
Continental Championships. Duathlon Standard distance.	Elite, U23, Age Group
Continental Championships. Duathlon Sprint distance	Elite, U23, Junior, Age Group, Paratriathlon
Continental Championships. Duathlon Team relay	Elite, Junior
Continental Championships. Duathlon Long distance.	Elite, Age Group, Paratriathlon.
Continental Championships. Winter Triathlon	Junior, U23, Elite, Age group. Team Relay. Paratriathlon PT ₂ , PT ₃ and PT ₄
Continental Championships. Aquathlon.	Junior, U23, Elite, Age group, Paratriathlon
Continental Championships. Cross Triathlon.	Junior, U23, Elite, Age group. Team Relay. Paratriathlon PT ₂ , PT ₃ and PT ₄
Continental Cup (All distances and all multisports)	Elite
Continental Tour events	Elite
Junior Continental Cup. Triathlon	Junior

32. APPENDIX K: PENALTIES AND VIOLATIONS:

This list is a resume of the most common penalties and infringements. In case of different interpretation of the text in this appendix and the main body of the Competition Rules, will be applied what is written in the main body of the Competition Rules.

All the references to Elite in the charts below, include Elite, U23, Junior and Youth athletes

General	
Rules	Penalties
1. Compete within 36 hours in more than one event of the same individual related multisport;	- DSQ from all the events included in this period.
2. Failing to follow the prescribed course;	- Stop and go and re-enter the race by the same point. If fails to that DSQ
3. Using abusive language or behaviour toward any official;	- DSQ and report to the ITU Arbitration Tribunal for possible suspension
4. Using unsportsmanlike behavior;	- DSQ and report to the ITU Arbitration Tribunal for possible suspension
5. Blocking, charging, obstructing, or interfering the forward progress of another athlete;	- Unintentionally: verbal warning - Intentionally: DSQ
6. Unfair contact. The fact that contact occurs between athletes does not constitute a violation. When several athletes are moving in a limited area, contact may occur. This incidental contact between athletes in equally favourable positions, is not a violation;	- Unintentionally: verbal warning - Intentionally: DSQ
7. Accepting assistance from anyone other than a Technical Official, race official or other athlete	- If it is possible to amend and return to the original situation Stop and go - If not: DSQ
8. Refusing to follow the instructions of Technical Officials or race officials;	- DSQ
9. Departing the course for reasons of safety, but failing to re-enter at the point of departure;	- Unintentionally: verbal warning, and correct if possible - Specifically, on the bike, if advantage is gained: - AG: 30 seconds in T2 (middle and long distance) - AG: 15 seconds in T2 (standard distance) - AG: 10 seconds in T2 (sprint distance) - Elite: 30 seconds in the penalty box (middle and long distance) - Elite: 15 seconds in the penalty box (standard distance) - Elite: 10 seconds in the penalty box (sprint distance and relay)
10. Failure to wear the unaltered race numbers if provided by the Local Organising Committee, in the proper way	- Stop and go, once corrected - If not; DSQ

ordered by the Technical Delegate and announced at the Athletes' Briefing;	
11. To dispose of rubbish or equipment around the course outside the clearly identified places, such as aid stations or rubbish disposal points.	<ul style="list-style-type: none"> - Stop and go, once corrected - If not time penalty in the run penalty box <ul style="list-style-type: none"> - 30 seconds (middle and long distance) - 15 seconds (standard distance) - 10 seconds (sprint distance)
12. Using illegal, dangerous or unauthorised equipment to provide an advantage or which will be dangerous to others;	<ul style="list-style-type: none"> - Stop and go, once corrected - If not: DSQ
13. Violating race-specific traffic regulations;	<ul style="list-style-type: none"> - Unintentionally: verbal warning, and correct if possible - Intentionally: DSQ
14. Contrived or intentional ties by elite, U23, junior and youth athletes, or Paratriathletes in ITU sanctioned events;	<ul style="list-style-type: none"> - DSQ
15. Wearing a different uniform than the one presented in the check-in, either in competition or in the award ceremony;	<ul style="list-style-type: none"> - DSQ
16. Wearing during the competition or the award ceremony an uniform which doesn't meet the Competition Rules	<ul style="list-style-type: none"> - DSQ
17. Displaying any kind of demonstration of political, religious or racial propaganda	<ul style="list-style-type: none"> - DSQ
18. Fraud by entering under an assumed name or age, falsifying an affidavit, or giving false information;	<ul style="list-style-type: none"> - DSQ and inform ITU ITU Arbitration Tribunal for a possible suspension
19. Participating when not eligible;	<ul style="list-style-type: none"> - DSQ and inform ITU ITU Arbitration Tribunal for a possible suspension
20. Repeated violations of ITU Rules;	<ul style="list-style-type: none"> - DSQ and inform ITU ITU Arbitration Tribunal for a possible suspension
21. Drug abuse;	<ul style="list-style-type: none"> - Penalties will apply according to the WADA rules
22. For an unusual and violent act of unsportsmanlike behaviour;	<ul style="list-style-type: none"> - Expulsion
23. Compete with a bare torso;	<ul style="list-style-type: none"> - Stop and go, once corrected - If not: DSQ
24. Indecent exposure	<ul style="list-style-type: none"> - Stop and go, once corrected - If not: DSQ
25. Outside assistance. To give another athlete a complete bike, frame, wheel(s), helmet, bike shoes or any other item equipment which results in the donor athlete being unable to continue with their own race	<ul style="list-style-type: none"> - DSQ of both athletes.
26. Attempt to gain unfair advantage from any external vehicle or object	<ul style="list-style-type: none"> - DSQ
27. Nudity or indecent exposure;	<ul style="list-style-type: none"> - DSQ

28. Not stopping in the next penalty box being obliged to do so;	- DSQ
29. Displaying any kind of demonstration of political, religious or racial propaganda.	- Stop and go, once corrected - If not: DSQ
30. Warming up on the course while another race is in progress;	- Warning and amend - If not corrected: DSQ
31. Competing under suspension	- DSQ and report to ITU Arbitration Tribunal for extending suspension or expulsion.
32. Carrying out ambush marketing in the award ceremony	- Forfeit the prize money earned in the event.

Briefing	
Rules	Penalties
33. Not attending the Athletes' Briefing, without notifying the TD;	- Athletes not attending the briefing, without informing the TD about their absence, will be removed from the start list of the event and from all start and wait list in the events on the next 30 days.
34. Athletes entering the briefing hall after the briefing has started and athletes not attending the briefing but informed the TD about their absence	- Reallocation in the last positions of the pre start line up
35. Athletes missing 3 or more briefing in World Cup or World Triathlon Series in the same calendar year, no matter if the athlete informed the TD or not	- DSQ from every subsequent race at which they miss the briefing.

Start	
Rules	Penalties
36. Starting before the starter's signal;	- Time penalty in T ₁ - 30 seconds (middle and long distance) - 15 seconds (standard distance) - 10 seconds (sprint distance)
37. Not moving forward before touching the water	- Time penalty in T ₁ - 30 seconds (middle and long distance) - 15 seconds (standard distance) - 10 seconds (sprint distance)
38. To change the start position once selected;	- Warning and amend. - If not DSQ
39. To block more than one start positions;	- DSQ

Swim	
Rules	Penalties
40. Wearing clothing covering any part of the arms below the shoulder and/or clothing covering any part of the legs below knee, in a non-wetsuit swim.	<ul style="list-style-type: none"> - Warning and amend - If not corrected: DSQ

Transition	
Rules	Penalties
41. Rack the bike improperly, outside the athletes' own space or blocking the progress of other athletes.	<ul style="list-style-type: none"> - Before the race warning and amend - During the race: <ul style="list-style-type: none"> - Age Group: Stop and go, once corrected - Elite: 30 seconds in the penalty box (middle and long distance) - Elite: 15 seconds in the penalty box (standard distance) - Elite: 10 seconds in the penalty box (sprint distance and relay)
42. To have the helmet strap fastened in T1 while completing the first segment.	<ul style="list-style-type: none"> - AG: TO will undo the strap. - Elite: TO will undo the strap and time penalty in T1. <ul style="list-style-type: none"> - 30 seconds (middle and long distance) - 15 seconds (standard distance) - 10 seconds (sprint distance)
43. Wearing the helmet unfastened or insecurely fastened, inside transition area while in possession of the bike.	<ul style="list-style-type: none"> - Age Group: Stop and go when corrected - Elite: 30 seconds in the penalty box (middle and long distance) - Elite: 15 seconds in the penalty box (standard distance) - Elite: 10 seconds in the penalty box (sprint distance)
44. Mount the bike before the mount line;	<ul style="list-style-type: none"> - Age Group: Stop and go, once corrected - Elite: 30 seconds in the penalty box (middle and long distance) - Elite: 15 seconds in the penalty box (standard distance) - Elite: 10 seconds in the penalty box (sprint distance and relay)
45. Dismount the bike after the dismount line;	<ul style="list-style-type: none"> - Age Group: Stop and go, once corrected - Elite: 30 seconds in the penalty box (middle and long distance) - Elite: 15 seconds in the penalty box (standard distance) - Elite: 10 seconds in the penalty box (sprint distance and relay)
46. Discharge or store the athlete equipment outside the designated area;	<ul style="list-style-type: none"> - Stop and go, once corrected - Elite: 30 seconds in the penalty box (middle and long distance) - Elite: 15 seconds in the penalty box (standard distance) - Elite: 10 seconds in the penalty box (sprint distance and relay)
47. Marking of position in transition area;	<ul style="list-style-type: none"> - Warning and amend - If not corrected, marking and objects used for marking purposes will be removed and athlete will not be notified

Bike	
Rules	Penalties
48. Not wearing helmet during bike familiarisation and/or official bike training sessions.	- To be excluded from the specific session
49. Make forward progress without the bike, during the bike segment;	- Stop and go, once corrected - If not: DSQ
50. Draft in a draft-illegal race on sprint distance events;	- 1st offence: 1 minute in the next penalty box - 2nd offence: DSQ
51. Draft in a draft-illegal race on standard distance events;	- 1st offence: 2 minutes in the next penalty box - 2nd offence: DSQ
52. Draft in a draft-illegal race on middle or long distance events;	- 1st and 2nd offences: 5 minutes in the next penalty box - 3rd offence: DSQ
53. Drafting off a different gender athlete in draft legal events	- 1 st offence verbal warning - 2 nd offence DSQ
54. Blocking in a draft illegal race	- Stop and go in the next penalty box
55. Wearing the helmet unfastened or insecurely fastened, during the bike segment;	- Stop and go, once corrected - If not: DSQ
56. Take off the helmet on the bike course, even if stopped;	- Stop and go, once corrected - If not: DSQ
57. Not wearing a helmet during the bike segment;	- DSQ
58. Competing with a different bicycle than the one presented at the check in, or modified after getting the approval at the check in	- DSQ

Run and Ski.	
Rules	Penalties
59. Crawl during the running segment;	- DSQ
60. Run together with other athlete/s that is/are one or more laps ahead. (Applicable to Elite, U23, Junior, Youth athletes and Paratriathletes)	- Stop and go, once corrected - If not; DSQ
61. Run or ski wearing a helmet;	- Stop and go, once corrected - If not; DSQ
62. To use posts, trees or other fixed elements to assist maneuvering curves;	- Elite: 30 seconds in the penalty box (middle and long distance) - Elite: 15 seconds in the penalty box (standard distance) - Elite: 10 seconds in the penalty box (sprint distance and relay)

Team Relay Specific	
Rules	Penalties
63. Team relay exchange completed outside of the exchange zone;	- Time penalty 10 seconds.
64. Team relay exchange not completed, or intentionally completed outside the changing zone	- DSQ

Paratriathlon Specific	
Rules	Penalties
65. AG or Paratriathletes accumulating 2 time penalties in Standard and shorter events.	- DSQ
66. AG or Paratriathletes accumulating 3 time penalties in middle and long distance events.	- DSQ
67. Paratriathletes , who use catheters or other urinary diversion devices, have spillage during training, competition or classification	- Warning and amend - If not corrected: DSQ
68. Paratriathlete attending a paratriathlon competition by using illegal equipment	- Before the race warning and amend - If not corrected: DSQ
69. Paratriathlete without a temporary, review or confirmed class status according to the regulated timelines	- DSQ
70. Paratriathlete compete wearing or using any prostheses or special adaptive equipment which are not officially approved	- Before the race warning and amend - If not corrected: DSQ
71. Paratriathletes using unprotected sharp objects, screws, prosthetic liners, or prosthetic devices that can be harmful	- DSQ
72. Paratriathlete, not competing during the paratriathlon classification process	- Warning and amend - If not corrected: DSQ
73. Athlete who have been evaluated as unclassified during the paratriathlon classification process	- Remove from the start list
74. Athlete who have been non eligible for a paratriathlon competition	- Remove from the start list
75. Paratriathlete fails to attend scheduled classification session	- Reasonable explanation: Give second chance - If not: DSQ
76. Paratriathlete who is intentionally misrepresenting his/her skills and/or abilities.	- DSQ - not allow the Paratriathlete to undergo any further evaluation for a minimum of two (2) years from the date upon which the

	<p>Paratriathlete intentionally misrepresented skills and/or abilities;</p> <ul style="list-style-type: none"> - remove any Sport Class or Sport Class Status allocated to the Paratriathlete from the Classification Master List; - designate the Paratriathlete as IM (intentional misrepresentation) in the <i>Classification Master List</i>; - Second offense: lifetime ban from any ITU events.
77. Guides and personal handlers, who have not registered at the athletes' briefing	<ul style="list-style-type: none"> - Do not have access to the FOP
78. Personal handler not carrying the special credentials which were given by the LOC/ITU	<ul style="list-style-type: none"> - Warning and amend - If not corrected: DSO the Paratriathlete that they are handling
79. Paratriathlete receiving help from more personal handlers that he/she has registered	<ul style="list-style-type: none"> - DSO
80. Any action taken by the personal handler which propels the competitor forward	<ul style="list-style-type: none"> - DSO the Paratriathlete that he/she is handling
81. Personal handler repairing a Paratriathlete's bike in an area other than the athletes' transition spot or the wheel station during the race	<ul style="list-style-type: none"> - DSO
82. Paratriathletes' equipments in the pre-transition area which haven't been registered	<ul style="list-style-type: none"> - Before the race warning and amend - If not corrected: DSO
83. Personal handlers' present in the pre-transition area from PT2, PT3, PT4 and PT5	<ul style="list-style-type: none"> - Before the race warning and amend - If not corrected: DSO the athlete that they are handling
84. PT1 paratriathletes doing the transition outside the individual space	<ul style="list-style-type: none"> - Time penalty at the run penalty box.
85. Paratriathletes leaving equipment in pre-transition after exiting it.	<ul style="list-style-type: none"> - Warning and amend - If not corrected: time penalty at the run penalty box.
86. PT5 athletes competing with a guide who is not complying the requirements	<ul style="list-style-type: none"> - DSO
87. PT5 athletes not be tethered during the swim or the run	<ul style="list-style-type: none"> - Before the race warning and amend - If not corrected: DSO
88. PT5 athletes paced, led or being more than 1.5m away from their guide, during the swim	<ul style="list-style-type: none"> - 10 seconds in T1 - Second offence: DSO
89. PT5 athletes paced, leaded or being more than 0.5m away from their guide, during the run	<ul style="list-style-type: none"> - First offence: 10 seconds in the next penalty box - Second offence: DSO
90. PT5 athletes pulled or pushed by the guide	<ul style="list-style-type: none"> - DSO

91. PT5 competitor crosses the finish line and the guide is beside or behind the competitor but further apart than the required 0.5 metres maximum separation distance	- DSQ
92. Paratriathlete enters the FOP with a guide dog	<ul style="list-style-type: none"> - Before the race warning and amend - If not corrected: DSQ
93. PT5 B1 Athletes not wearing blackout glasses during the run segment	- DSQ

Where to serve the Time Penalties

	Elite Draft Illegal	Elite Draft Legal	Age Group Draft Illegal	Age Group Draft Legal	Elite Paratriathlon	Open Paratriathlon
Start	T ₁	T ₁	T ₁	T ₁	T ₁	T ₁
Swim	T ₁	T ₁	T ₁	T ₁	T ₁	T ₁
Transition 1	Run penalty box	Run penalty box	Stop and go at T ₁	Stop and go at T ₁	Run penalty box	Stop and go at T ₁
Bike	Bike penalty box	Run penalty box	Bike penalty box	Stop and go at T ₂	Bike penalty box	Bike penalty box
Transition 2	Run penalty box	Run penalty box	Stop and go at T ₂	Stop and go at T ₂	Run penalty box	Stop and go at T ₂
Run	Run penalty box	Run penalty box	Stop and go	Stop and go	Run penalty box	Stop and go

Notes:

All the references to Elite includes Elite, U23, Junior and Youth athletes. In Winter Triathlon run penalty box is replaced with ski penalty box. In Duathlon and Aquathlon events run penalty box means 2nd run penalty box.

33. APPENDIX L RESULTS AND START LIST SAMPLES

APPENDIX L1: RESULTS SAMPLES

A. Individual Events

<Name of the event>

<Date of the event>

<Program results> I.e. Elite men; 45-49 AG Women

Race details:	Swim: xxxx m/x laps; Bike: xx.x km/x laps; Run: xx.x km/x laps
Race conditions:	Water temperature xx.x C; Air temperature xx.x C; (No) wetsuit swim
Technical Delegate:	<Last Name>, <First Name>/<NF Code>
Race Referee:	<Last Name>, <First Name>/<NF Code>
Competition Jury:	<Last Name>, <First Name>/<NF Code>, TD <Last Name>, <First Name>/<NF Code> <Last Name>, <First Name>/<NF Code>

(This information can be shown also as a footer note)

POSITION			NAT.	RACE No	TIME	SWIM	T1	BIKE	T2	RUN
1	Annelise	Butterfly	GBR	4	01:03:34	00:11:15	00:00:30	00:33:48	00:00:42	00:17:20
2	Annelise	Butterfly	USA	1	01:04:27	00:11:11	00:00:31	00:34:35	00:00:45	00:17:25
3	Annelise	Butterfly	IRL	3	01:05:10	00:11:08	00:00:30	00:33:56	00:00:44	00:18:53
4	Annelise	Butterfly	CAN	5	01:05:24	00:11:55	00:00:42	00:34:01	00:00:45	00:18:02
5	Annelise	Butterfly	SRB	12	01:05:32	00:11:20	00:00:37	00:34:08	00:00:45	00:18:42
6	Annelise	Butterfly	ESP	8	01:05:50	00:11:57	00:00:34	00:34:09	00:00:45	00:18:26
7	Annelise	Butterfly	FRA	6	01:06:32	00:11:19	00:00:30	00:34:28	00:00:46	00:19:29
8	Annelise	Butterfly	POR	9	01:06:43	00:11:22	00:00:48	00:34:33	00:00:48	00:19:12
9	Annelise	Butterfly	RSA	11	01:06:58	00:12:24	00:00:33	00:33:43	00:00:49	00:19:30
10	Annelise	Butterfly	MAR	16	01:07:03	00:10:08	00:00:36	00:34:49	00:00:47	00:20:42
DNF	Annelise	Butterfly	BAR	7	00:00:00	00:12:01	00:00:28	00:33:49	00:00:42	00:00:00
DNF	Annelise	Butterfly	CHI	19	00:00:00	00:12:01	00:00:28	00:36:38	00:00:42	00:00:00
LAP	Annelise	Butterfly	KOR	21	00:00:00	00:13:14	00:00:00	00:00:00	00:00:00	00:00:00
DNF	Annelise	Butterfly	MEX	20	00:00:00	00:13:28	00:00:00	00:00:00	00:00:00	00:00:00
DSQ	Annelise	Butterfly	MEX	23	00:00:00	00:00:00	00:00:00	00:00:00	00:00:00	00:00:00
DNS	Annelise	Butterfly	MEX	22	00:00:00	00:00:00	00:00:00	00:00:00	00:00:00	00:00:00
DNS	Annelise	Butterfly	MEX	24	00:00:00	00:00:00	00:00:00	00:00:00	00:00:00	00:00:00

B.

C. Mixed Relay Events

<Name of the event>

<Date of the event>

<Program results> I.e. Mixed Relay Elite ;Mixed Relay Junior

Race details:	Swim: xxxx m/x laps; Bike: xx.x km/x laps; Run: xx.x km/x laps (Show the differences if 1 st otr 4 th relay are different)
Race conditions:	Water temperature xx.x C; Air temperature xx.x C; (No) wetsuit swim
Technical Delegate:	<Last Name>, <First Name>/<NF Code>
Race Referee:	<Last Name>, <First Name>/<NF Code>
Competition Jury:	<Last Name>, <First Name>/<NF Code>, TD <Last Name>, <First Name>/<NF Code> <Last Name>, <First Name>/<NF Code>

(This information can be shown also as a footer note)

Rk	Race No.			Time	Swim	T1	Bike	T2	Run
1	1	ITA	Team I	0:51:24					
		Beatrice	Bevilacqua	0:12:54	0:03:00	0:00:15	0:05:05	0:00:30	0:04:04
		Antonio	Antonioli	0:12:37	0:03:01	0:00:14	0:05:09	0:00:33	0:03:40
		Sofia	Santimaria	0:13:18	0:03:02	0:00:13	0:05:13	0:00:36	0:04:14
		Piero	Pauli	0:12:35	0:03:03	0:00:12	0:05:17	0:00:30	0:03:33
2	15	RSA	Team I	0:52:04					
		Cindy	Carter	0:13:04	0:03:02	0:00:15	0:05:13	0:00:30	0:04:04
		William	Wonder	0:12:47	0:03:03	0:00:14	0:05:17	0:00:33	0:03:40
		Daria	Delly	0:13:28	0:03:04	0:00:13	0:05:21	0:00:36	0:04:14
		Peter	Pundio	0:12:45	0:03:05	0:00:12	0:05:25	0:00:30	0:03:33
3	33	CHN	Team I	0:54:09					
		Li	Li	0:13:24	0:03:04	0:00:15	0:05:21	0:00:30	0:04:14
		Whang	Gao	0:12:57	0:03:05	0:00:14	0:05:25	0:00:33	0:03:40
		Linin	Xi	0:14:53	0:03:06	0:00:13	0:05:29	0:00:36	0:05:29
		Feng	Feng	0:12:55	0:03:07	0:00:12	0:05:33	0:00:30	0:03:33
NC	21	ITA	Team II	0:54:24					
		Maria	Antonioli	0:13:34	0:03:04	0:00:15	0:05:21	0:00:30	0:04:24
		Piero	Santimaria	0:12:57	0:03:05	0:00:14	0:05:25	0:00:33	0:03:40
		Elena	Pauli	0:14:58	0:03:06	0:00:13	0:05:29	0:00:36	0:05:34
		Giorgio	Sandrini	0:12:55	0:03:07	0:00:12	0:05:33	0:00:30	0:03:33

D. PT5 Events

<Name of the event>

<Date of the event>

<Program results> I.e. PT5 Men, PT5 Women

Race details: Swim: xxxx m/x laps; Bike: xx.x km/x laps; Run: xx.x km/x laps
 Race conditions: Water temperature xx.x C; Air temperature xx.x C; (No) wetsuit swim
 Technical Delegate: <Last Name>, <First Name>/<NF Code>
 Race Referee: <Last Name>, <First Name>/<NF Code>
 Competition Jury: <Last Name>, <First Name>/<NF Code>, TD
 <Last Name>, <First Name>/<NF Code>
 <Last Name>, <First Name>/<NF Code>

Interval start: athletes marked with B1 started the race X:XX before the rest. The split shown are the real ones. The total time shown for the non B1 athletes is the result to add X:XX to the splits shown.

ONLY FOR THIS SAMPLE X:XX is 1:11

(This information can be shown also on a footer note)

POSITION			NAT.	RACE No	TIME	SWIM	T1	BIKE	T2	RUN
1	Annelise	Butterfly	GBR	4	01:03:34	00:11:15	00:00:30	00:33:48	00:00:42	00:17:20
2	Annelise	Butterfly B1	USA	1	01:04:27	00:10:00	00:00:31	00:34:35	00:00:45	00:17:25
3	Annelise	Butterfly	IRL	3	01:05:10	00:11:08	00:00:30	00:33:56	00:00:44	00:18:53
4	Annelise	Butterfly	CAN	5	01:05:24	00:11:55	00:00:42	00:34:01	00:00:45	00:18:02
5	Annelise	Butterfly	SRB	12	01:05:32	00:11:20	00:00:37	00:34:08	00:00:45	00:18:42
6	Annelise	Butterfly B1	ESP	8	01:05:50	00:10:46	00:00:34	00:34:09	00:00:45	00:18:26
7	Annelise	Butterfly B1	FRA	6	01:06:32	00:10:08	00:00:30	00:34:28	00:00:46	00:19:29
8	Annelise	Butterfly B1	POR	9	01:06:43	00:10:11	00:00:48	00:34:33	00:00:48	00:19:12
9	Annelise	Butterfly	RSA	11	01:06:58	00:12:24	00:00:33	00:33:43	00:00:49	00:19:30
10	Annelise	Butterfly	MAR	16	01:07:03	00:10:08	00:00:36	00:34:49	00:00:47	00:20:42
DNF	Annelise	Butterfly	BAR	7	00:00:00	00:12:01	00:00:28	00:33:49	00:00:42	00:00:00
DNF	Annelise	Butterfly	CHI	19	00:00:00	00:12:01	00:00:28	00:36:38	00:00:42	00:00:00
LAP	Annelise	Butterfly	KOR	21	00:00:00	00:13:14	00:00:00	00:00:00	00:00:00	00:00:00
DNF	Annelise	Butterfly	MEX	20	00:00:00	00:13:28	00:00:00	00:00:00	00:00:00	00:00:00
DSQ	Annelise	Butterfly	MEX	23	00:00:00	00:00:00	00:00:00	00:00:00	00:00:00	00:00:00
DNS	Annelise	Butterfly	MEX	22	00:00:00	00:00:00	00:00:00	00:00:00	00:00:00	00:00:00
DNS	Annelise	Butterfly	MEX	24	00:00:00	00:00:00	00:00:00	00:00:00	00:00:00	00:00:00

APPENDIX L2: PT5 INTERVAL START LIST SAMPLES

A. PT5 Men start list

To be used when the schedule separates men and women starts

Start number	Name	NF	Sub Class	Start time
1	Svensson, Lars	SWE	B1	00:00:00
2	Arkajanow, Nikolai	RUS	B1	00:00:00
3	Nice, John	USA	B2	00:XX:XX
4	Goodwill, David	AUS	B2	00:XX:XX
5	Krecek, Jan	CZE	B3	00:XX:XX
6	Crogic, Gergely	CRO	B3	00:XX:XX

B. PT5 Women start list

To be used when the schedule separates men and women starts

Start number	Name	NF	Sub Class	Start time
11	Smith, Petra	GER	B1	00:00:00
12	Donner, Melissa	USA	B1	00:00:00
13	Williams, Lucy	AUS	B2	00:YY:YY
14	Merini, Sofia	ITA	B2	00:YY:YY
15	Jun, Ji	KOR	B3	00:YY:YY
16	Mendes, Fernanda	POR	B3	00:YY:YY

C. PT5 Men and women start list

To be used when the schedule combines men and women starts

Start number	Name	NF	Sub Class	Start time
11	Smith, Petra	GER	B1 F	00:00:00
12	Donner, Melissa	USA	B1 F	00:00:00
1	Svensson, Lars	SWE	B1 M	00:00:00
2	Arkajanow, Nikolai	RUS	B1 M	00:00:00
3	Nice, John	USA	B2 M	00:XX:XX
4	Goodwill, David	AUS	B2 M	00:XX:XX
5	Krecek, Jan	CZE	B3 M	00:XX:XX
6	Crogic, Gergely	CRO	B3 M	00:XX:XX
14	Williams, Lucy	AUS	B2 F	00:YY:YY
15	Merini, Sofia	ITA	B2 F	00:YY:YY
16	Jun, Ji	KOR	B3 F	00:YY:YY
17	Mendes, Fernanda	POR	B3 F	00:YY:YY

Time Compensation values (00:XX:XX and 00:YY:YY) for a Paratriathlon events officially approved as Sprint triathlon by ITU are published in the document called: "PT5 compensation times":

http://www.competitions.com/about/downloads/category/competition_rules

34. APPENDIX M: ATHLETE'S AGREEMENT

1. **Governing Body:** The Athlete acknowledges that ITU is the sole world governing body for the sports of triathlon, Paratriathlon, Duathlon and its related other multisports world-wide and that ITU is recognized by the IOC and the IPC, is a member of ASOIF and is a member of SportAccord.
2. **Definition of Terms:**

ASOIF	The Association of Summer Olympic International Federations.
Athlete	The person signing this document.
Intellectual Property Rights	Individual intellectual property rights (including the rights to the Image or any name or mark of the Athlete).
Sport Accord	Formerly The General Association of International Sports Federations (GAISF).
Image	The Athlete's name, likeness, signature, biographical information, image, other identifying insignia or characteristics and any similar or associated trademarks.
ITU Events	The events listed on the "Events" section of www.triathlon.org , including Continental Confederations events.
ITU Rules	The ITU Anti-Doping Rules, the ITU Constitution and By-Laws, the ITU Competition Rules, including its appendixes being one of them the ITU Uniform Rules, the ITU Event Organisers Manual and all other ITU rules, regulations and guidelines issued or in force from time to time.
IOC	The International Olympic Committee.
IPC	The International Paralympic Committee
National Federation or NF	The Athlete's National Federation.
Partners	Any non-related and related bodies corporate of ITU or agency of ITU.
ITU Uniform Rules	The rules which outline the size, location and type of logos and branding the Athlete's uniform must abide by at all ITU events. These rules are stated in this document.
WADA	The World Anti Doping Agency.
3. **ITU Property:** The Athlete acknowledges that ITU Events are the exclusive property of ITU which owns all rights associated including, without limitation, the rights to organise, exploit, broadcast and reproduce ITU Events and the athlete's data provided to the event. The Athlete acknowledges that these rights include any type of digital media, whether that be photographic or video in nature, captured from within the boundaries of the field of play, regardless of ownership of the capturing device. All the personal data from the athlete enter into any ITU event and the data produced from the event, including the results are exclusive property of ITU.
4. **ITU Documents:** The Athlete acknowledges that he or she has access to a copy of the ITU Rules through his or her National Federation and the ITU website: www.triathlon.org. The Athlete agrees that upon signing this Agreement, he or she shall be deemed to be aware of and agree to be bound by the provisions of the ITU Rules, provided that the ITU Rules are posted 60 days prior to the event he or she is competing in.
5. **Eligibility to Compete:** The Athlete declares that he or she has not been guilty of any act or omission whereby he or she has become liable to be declared ineligible for selection or participation in any ITU Event in accordance with the rules of ITU or otherwise.
6. **ITU Media:** The Athlete agrees to update their athlete profile on the ITU website, www.triathlon.org, on a quarterly basis. The Athlete agrees mandatory participation in a pre-race press conference if asked to do so by ITU Media. The Athlete must also make themselves available

for ITU Media duties, including but not limited to pre- or post-race interviews, feature or promotional shoots or other media-related activities, for a minimum of one (1) hour at each event as requested by ITU Media. In turn, ITU Media shall endeavour to limit the number of times individual athletes are requested for media opportunities per season.

7. **ITU Uniform Rules:** The Athlete agrees to comply with all of the requirements of the ITU Uniform Rules.
8. **Failure to Start at ITU Events:** The Athlete acknowledges that if they are officially entered into an ITU event, but fail to be on the starting line at the event, their National Federation will be sanctioned as described in the Qualification Criteria for the different ITU Events.
9. **Failure to attend the Athlete Briefing:** The Athlete acknowledges that if he or she is not in attendance at the Athlete Briefing then the following may happen:
 - 9.1. He or she may not be allowed to start; and / or
 - 9.2. He or she may be given a disadvantageous spot at the starting line as described in the ITU Competition Rules and in the Qualification Criteria for the different ITU Events.
10. **Anti-doping Rules:** The Athlete will abide by the WADA Code and ITU Anti-Doping Rules.
 - 10.1. **Athlete Whereabouts:** The Athlete agrees to post and maintain his or her current location on the WADA website database (ADAMS,) or other method approved by ITU.
 - 10.2. **Therapeutic Use Exemption (TUE):** If applicable, the Athlete will have a Therapeutic Use Exemption (TUE) form on file at ITU.
 - 10.3. **Anti-doping Control Results:** The Athlete is aware that their NF will be responsible for reporting all anti-doping results on their Athletes to ITU.
11. **Liability:** The Athlete agrees that (save in the case of death or personal injury caused by the negligence of ITU or ITU's partners) neither ITU nor ITU's partners shall be, nor be deemed to be, responsible or liable (whether in contract or in tort or under any statute whatsoever), for any injury, illness or other mishap to the Athlete or the Athlete's property sustained in, or arising from or out of, in any way directly or indirectly connected with the ITU Events.
12. **Intellectual property:**
 - 12.1. In consideration of the acceptance of the Athlete's participation in ITU Events, the Athlete agrees to be filmed, broadcast, photographed, identified, interviewed and otherwise recorded during ITU Events for the purposes of the international media coverage of the relevant ITU Event (by means of all and any media throughout the world in perpetuity) and the promotion of the sport.
 - 12.2. The Athlete hereby assigns with full title guarantee in perpetuity to the ITU all rights of any nature in any such recordings. The Athlete further agrees that his or her Image and/or any photographs and/or moving Images taken of him/her (or other representations of him/her) may be used:
 - a.) by ITU and/or any Local Organising Committee for the purposes of publicising ITU Events and promoting the sport; and
 - b.) by official sponsors or other commercial partners of the Event on a free of charge worldwide basis for the purpose of promoting their sponsorship of/official relationship with ITU Events provided always that any such use of the Athlete's Image by such sponsors /commercial partners shall:
 - Be limited to Images of the Athlete taken or recorded whilst participating in ITU Events;
 - Not constitute an endorsement of their products and services by the Athlete; and

- Always feature the Image of the Athlete in a group / montage of at least 4 athletes (including the Athlete) in relation to which group no one athlete shall be featured in a manner which is significantly more prominent than any other.
 - The Athlete's Image may not be altered in any way shape or form, including but not limited to sponsor logos, or other branding.
- 12.3. The Athlete additionally consents to the use and reproduction of his/her Image in merchandise and publications relating to the ITU and/or ITU Events, apparel and publications provided always that such merchandise is primarily related to the Event itself as opposed to the Athlete personally:
- a.) ITU will not for any purposes enter into discussion with a computer game company without the written permission of all athletes to be included in the project.
 - b.) The Athlete agrees that all photographs and moving Images taken by him/her at the Event, including those of other athletes competing at the Event, shall be used solely for personal use and non-commercial purposes, unless prior written consent is obtained from the ITU.
 - c.) The Athlete further agrees that under no circumstances, throughout the duration of the Event, may he/she act as a journalist or in any other media capacity, nor shall he/she post or contribute any comment, text or photographs to any website or blog during the Event without the express permission of ITU. This does not include athletes writing or posting on their own personal social media accounts, including but not limited to Facebook, Twitter, their personal blog/website or any other such personally based social media that has yet to be invented.
- 12.4. The Athlete hereby assigns with full title guarantee in perpetuity to the ITU all data rights of any nature that have been entered by her/him or their National Federation in any ITU event and the results and classifications from any event he/she has taken part in.
13. **Restrictions on association with ITU:** The Athlete shall not grant any rights to use or utilise the Athlete's name, signature, photograph, likeness, reputation, image and identity or endorse any product or service in trade or commerce in such a way as to connote the sponsorship, approval or affiliation of ITU or any events conducted by or affiliated with ITU without the prior written permission of ITU.
14. **ITU Competition Rules:** Whilst participating in ITU Events or events endorsed by ITU, the Athlete agrees to abide by the ITU Competition Rules as applicable to the relevant ITU Event.
15. **Injury / Loss of Property:**
- 15.1. The Athlete agrees and acknowledges that participation in, or observation of sport, could constitute a risk of serious injury to him or herself, including permanent paralysis or death.
 - 15.2. The Athlete voluntarily and knowingly recognizes, accepts and assumes this risk and warrants to ITU and ITU's partners that the Athlete is physically fit and able to compete in ITU Events without risking serious injury, including permanent paralysis or death.
 - 15.3. Furthermore, the Athlete releases ITU, ITU's partners, their Sponsors, Event Sponsors, Event Organisers and Officials from any liability there from (save in the case of death or personal injury caused by the negligence of any of the aforementioned parties).
 - 15.4. The Athlete further agrees that he/she shall be responsible for any property that he/she brings to ITU Events and that ITU, ITU's partners, their Sponsors, Event Sponsors, Event Organisers and Officials shall have no responsibility for any loss or damage to such property.
 - 15.5. Furthermore the Athlete acknowledges and agrees that ITU shall have no obligation to arrange any insurances connected with his/her participation in ITU Events including without

limitation travel insurance and medical insurance, all of which insurances shall be the sole responsibility of the Athlete.

- 15.6. ITU will make a good-faith effort, with the LOC, to protect athlete's property in the athlete's lounge and transition area.
16. **Dispute:** The Athlete accepts that any dispute arising from regulations of ITU, which cannot be settled by its existing appeal procedure, as set out in the ITU Competition Rules, shall be settled finally by the Court of Arbitration for Sport (CAS), to the exclusion of recourse to ordinary courts. The applicable law in relation to the interpretation of this agreement and any such disputes shall be the law of Canton de Vaud, Switzerland.

ITU Athletes' Agreement

I, _____ (print name in block capitals) hereby acknowledge that I have read and understand these terms and conditions. I hereby accept and agree to be bound by the terms and conditions as set out in this document.

(Signature of Athlete)

(Date)

Please print legibly:

First Name:		
Family Name:		
National Federation:		
Street Address:		
City:		
Postal / Zip Code:		
Country:		
Telephone (home): (+ Country Code – telephone number)		
Telephone (mobile): (+ Country Code – telephone number)		
Email:		
Birthday: (day-month-year)		
Insurance Policy #:		
Person to contact in case of emergency:	Name:	
	Phone number:	
Coach's Name:		
Coach's Email:		
Coach's Mobile Phone:		